

vivitek[®]
Vivid Color, Vivid Life

**DX6530
DW6030
series**

>> *User's Manual*

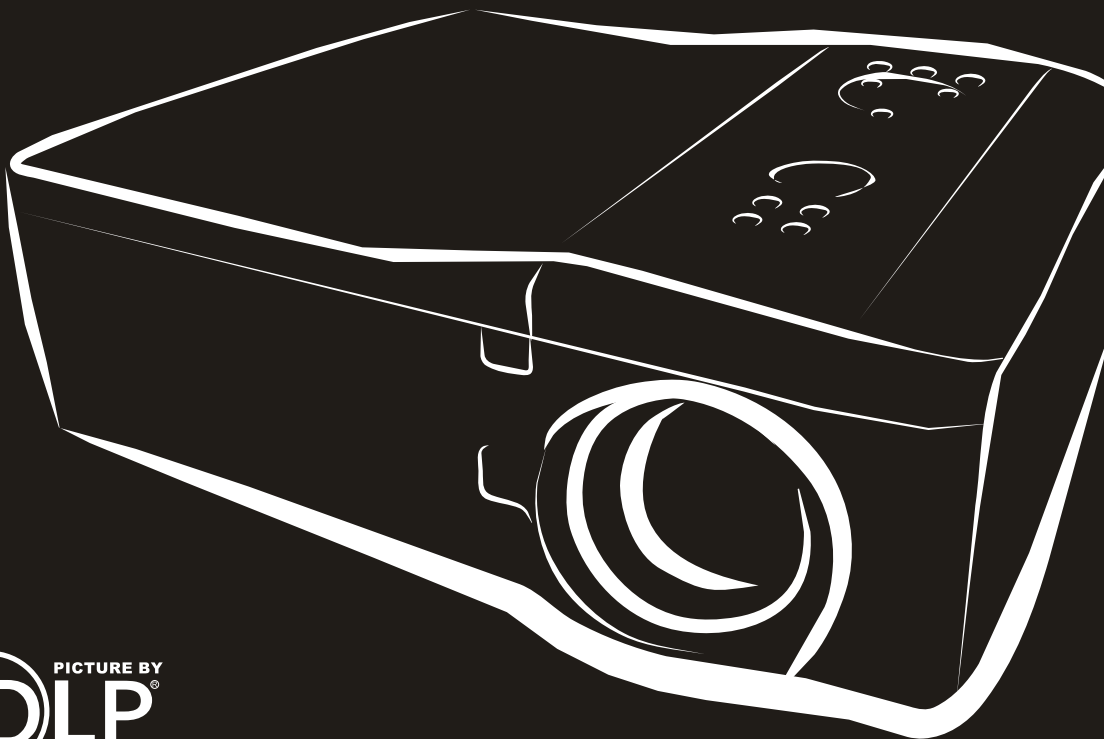

PICTURE BY
DLP[®]
TEXAS INSTRUMENTS

Copyright

This publication, including all photographs, illustrations and software, is protected under international copyright laws, with all rights reserved. Neither this manual, nor any of the material contained herein, may be reproduced without written consent of the author.

© Copyright 2013

Disclaimer

The information in this document is subject to change without notice. The manufacturer makes no representations or warranties with respect to the contents hereof and specifically disclaims any implied warranties of merchantability or fitness for any particular purpose. The manufacturer reserves the right to revise this publication and to make changes from time to time in the content hereof without obligation of the manufacturer to notify any person of such revision or changes.

Trademark Recognition

Kensington is a U.S. registered trademark of ACCO Brand Corporation with issued registrations and pending applications in other countries throughout the world.

All other product names used in this manual are the properties of their respective owners and are acknowledged.

Important Safety Information

Congratulations on purchasing the Vivitek DLP® projector!

Important:

It is strongly recommended that you read this section carefully before using the projector. These safety and usage instructions will ensure that you enjoy many years of safe use of the projector. Keep this manual for future reference.

Symbols Used

Warning symbols are used on the unit and in this manual to alert you of hazardous situations.

The following styles are used in this manual to alert you to important information.

Note:

Provides additional information on the topic at hand.

Important:

Provides additional information that should not be overlooked.

Caution:

Alerts you to situations that may damage the unit.

Warning:

Alerts you to situations that may damage the unit, create a hazardous environment, or cause personal injury.

Throughout this manual, component parts and items in the OSD menus are denoted in bold font as in this example:

“Push the **Menu** button on the remote control to open the **Main** menu.”

Remote Control

Some remote controls have a laser for pointing out items on a screen.

General Safety Information

- Do not open the unit case. Aside from the projection lamp, there are no user-serviceable parts in the unit. For servicing, contact qualified service personnel.
- Follow all warnings and cautions in this manual and on the unit case.
- The projection lamp is extremely bright by design. To avoid damage to eyes, do not look into the lens when the lamp is on.
- Do not place the unit on an unstable surface, cart, or stand.
- Avoid using the system near water, in direct sunlight, or near a heating device.
- Do not place heavy objects such as books or bags on the unit.

Power Safety

- Only use the supplied power cord.
- Do not place anything on the power cord. Place the power cord where it will not be in the way of foot traffic.
- Remove the batteries from the remote control when storing or not in use for a prolonged period.

Replacing the Lamp

Replacing the lamp can be hazardous if done incorrectly. See Replacing the Lamps on page 54 for clear and safe instructions for this procedure. Before replacing the lamp:

- Unplug the power cord.
- Allow the lamp to cool for about one hour.

Important Recycle Instructions:



Lamp(s) inside this product contain mercury. This product may contain other electronic waste that can be hazardous if not disposed of properly. Recycle or dispose in accordance with local, state, or federal Laws. For more information, contact the Electronic Industries Alliance at WWW.EIAE.ORG. For lamp specific disposal information check WWW.LAMPRECYCLE.ORG.

Cleaning the Projector

- Unplug the power cord before cleaning. See Cleaning the projector on page 51.
- Allow the lamp to cool for about one hour.

Regulatory Warnings

Before installing and using the projector, read the regulatory notices in the Regulatory Compliance section on page 76.

Symbol Explanations



DISPOSAL: Do not use household or municipal waste collection services for disposal of electrical and electronic equipment. EU countries require the use of separate recycling collection services.

Projector Installation Notice

- Place the projector in a horizontal position
The tilt angle of the projector should not exceed 15 degrees, nor should the projector be installed in any way other than the desktop and ceiling mount, otherwise lamp life could decrease dramatically, and may lead to other **unpredictable damages**.



- Allow at least 50 cm clearance around the exhaust vent.

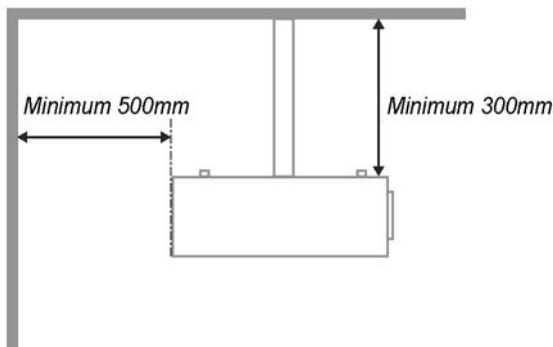
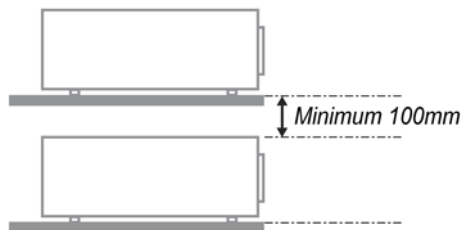
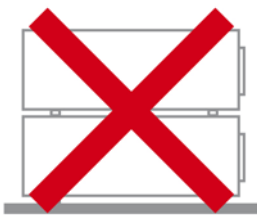
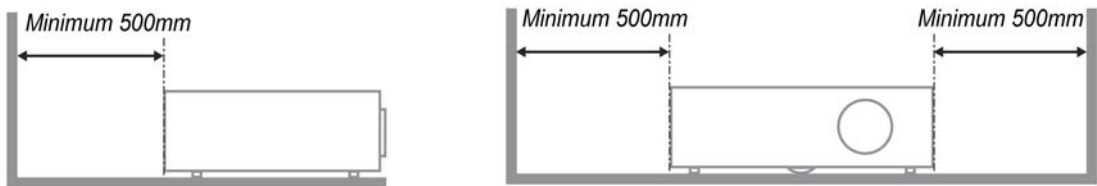

- Ensure that the intake vents do not recycle hot air from the exhaust vent.
- When operating the projector in an enclosed space, ensure that the surrounding air temperature within the enclosure does not exceed operation temperature while the projector is running, and the air intake and exhaust vents are unobstructed.
- All enclosures should pass a certified thermal evaluation to ensure that the projector does not recycle exhaust air, as this may cause the device to shutdown even if the enclosure temperature is within the acceptable operation temperature range.

About this manual

This manual is intended for end users and describes how to install and operate the DLP projector. Whenever possible, relevant information—such as an illustration and its description—has been kept on one page. This printer-friendly format is both for your convenience and to help save paper, thereby protecting the environment. It is suggested that you only print sections that are relevant to your needs.

Table of Contents

INTRODUCTION.....	1
PACKING CHECKLIST	1
VIEWS OF PROJECTOR PARTS.....	2
<i>Front-right View</i>	2
<i>Bottom view</i>	3
TOP FEATURES.....	4
<i>OSD Controls and Status LEDs</i>	4
TERMINAL PANEL FEATURES.....	5
REMOTE CONTROL	6
REMOTE CONTROL OPERATING RANGE.....	7
SETUP AND OPERATION.....	8
INSERTING THE REMOTE CONTROL BATTERIES	8
INSTALLING OR REMOVING THE OPTIONAL LENS	9
<i>Removing the Existing Lens From the Projector</i>	9
<i>Installing the New Lens</i>	10
THROW DISTANCE AND SCREEN SIZE	11
INSTALLING THE OPTIONAL COLOR WHEEL	13
MAKING CONNECTIONS	15
<i>Connecting Your PC or Macintosh Computer</i>	15
<i>Connecting an External Monitor</i>	16
<i>Connecting Your DVD Player with Component Output</i>	17
<i>Connecting Your VCR or Laser Disc Player</i>	18
PROJECTING AN IMAGE (BASIC OPERATION).....	19
TURNING ON THE PROJECTOR	19
SELECTING AN INPUT SOURCE	20
ADJUSTING THE PICTURE POSITION AND PICTURE SIZE	21
<i>Adjusting Picture Position Manually</i>	21
<i>Lens Shift Adjustable Range</i>	22
<i>Adjusting the Projector Level</i>	22
OPTIMIZING AN RGB IMAGE AUTOMATICALLY.....	23
<i>Adjusting the Image Using Auto Sync</i>	23
TURNING OFF THE PROJECTOR	24
<i>About Direct Power Off</i>	25
<i>After Use</i>	25
CONVENIENT FEATURES	26
FREEZING A PICTURE.....	26
ADJUSTING THE FOCUS/ZOOM MANUALLY	26
CHANGING LAMP MODE.....	27
<i>Changing Lamp Mode by Using the Projector's OSD Control Panel</i>	27
GETTING INFORMATION.....	27
<i>Correcting Keystone by Using the Remote Control</i>	28
PREVENTING THE UNAUTHORIZED USE OF THE PROJECTOR	29
<i>Locking the Projector</i>	29
<i>Unlocking the Projector</i>	30
USING THE PHYSICAL LOCK	30
<i>Using the Kensington Lock</i>	30
USING ON-SCREEN DISPLAY	31
USING THE MENUS	31
<i>Navigating the OSD</i>	31
MENU TREE	32
INPUT MENU DESCRIPTIONS AND FUNCTIONS	34
ADJUST MENU DESCRIPTIONS AND FUNCTIONS.....	35
<i>Picture</i>	35
<i>Signal Adjustment</i>	38

DLP Projector—DX6530/DX6535/DW6030/DW6035 User's Manual

Video Setting	39
Setup.....	40
Installation.....	45
MAINTENANCE.....	51
CLEANING THE PROJECTOR	51
<i>Cleaning the Cabinet</i>	51
<i>Cleaning the Lens</i>	51
<i>Cleaning the Filters</i>	52
<i>Replacing the Lamps</i>	54
APPENDIX.....	56
TROUBLESHOOTING	56
<i>Indicator Messages</i>	56
<i>Common Problems and Solutions</i>	57
<i>Tips for Troubleshooting</i>	57
IMAGE PROBLEMS.....	58
<i>Lamp Problems</i>	58
<i>Remote Control Problems</i>	59
HAVING THE PROJECTOR SERVICED	59
SPECIFICATIONS.....	60
PROJECTOR SPECIFICATIONS.....	60
<i>Lens options</i>	61
CABINET DIMENSIONS	61
PIN ASSIGNMENTS OF MINI D-SUB 15 PIN INPUT CONNECTOR.....	62
COMPATIBLE INPUT SIGNAL LIST	63
RS232 CONTROL COMMANDS AND CABLE CONNECTIONS	65
<i>Control Command</i>	66
SCREEN TRIGGER.....	70
OPERATION USING HTTP BROWSER	71
<i>Overview</i>	71
<i>Preparation Before Use</i>	71
<i>Handling of the Address for Operation by Using a Browser</i>	71
<i>Configuring Network Settings</i>	72
<i>Structure of the HTTP Server</i>	74
REGULATORY COMPLIANCE.....	76
FCC WARNING.....	76
CANADA	76
SAFETY CERTIFICATIONS.....	76
EN 55022 WARNING	76

INTRODUCTION

Packing Checklist

Carefully unpack the projector and check that the following items are included:

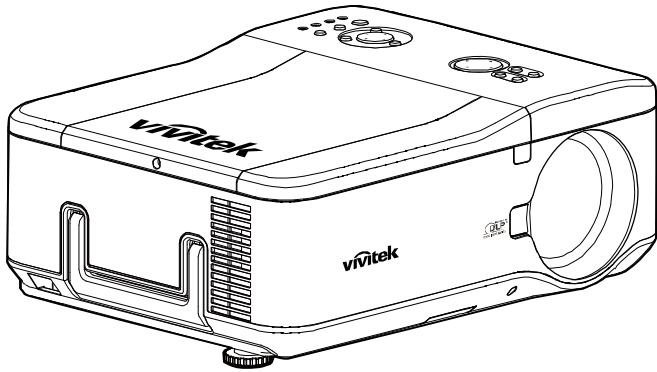

DLP PROJECTOR



REMOTE CONTROL

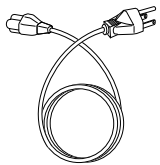

*POWER CORD
(FOR US MODEL)*

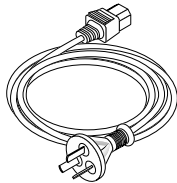

*POWER CORD
(FOR CHINA MODEL)*

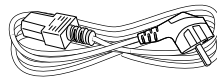

*POWER CORD
(FOR EU MODEL)*

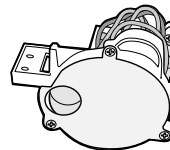

*6 SEGMENT
COLOR WHEEL*

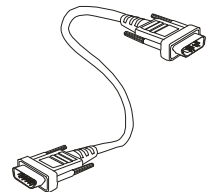

VGA CABLE



*CD-ROM
(THIS USER'S MANUAL)*



*LENS HOLE CAP
(INSTALLED)*

Contact your dealer immediately if any items are missing, appear damaged, or if the unit does not work.

Caution:
Avoid using the projector in dusty environments.

Views of Projector Parts

Front-right View

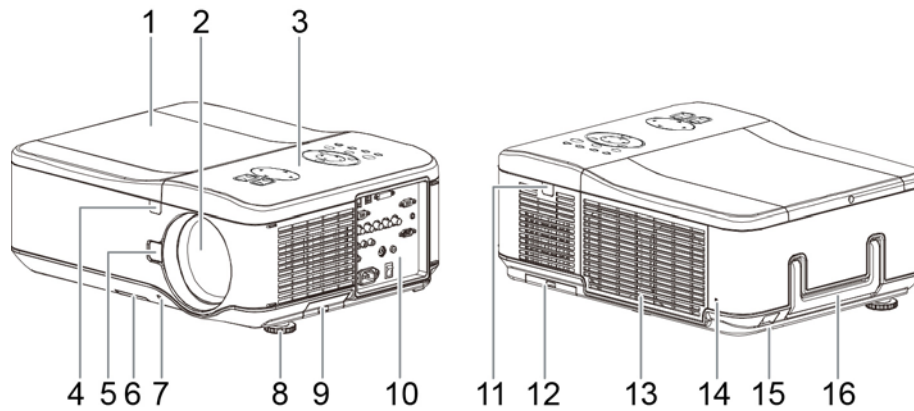

ITEM	LABEL	DESCRIPTION
1.	Lamp cover	Remove cover to replace lamp or color wheel
2.	Lens	Remove lens cap before use
3.	OSD control panel	See OSD Controls and Status LEDs
4.	IR receiver	Receiver for IR signal from remote control
5.	Lens Change button	Press the Lens Change button before removing the lens
6.	Intake vent	Lamp cooling vent – do not obstruct
7.	Lens cap	Cover lens to protect when not in use
8.	Height adjuster	Adjust level of projector
9.	Intake vent	Lamp cooling vent – do not obstruct
10.	I/O connector panel	Connect various input devices
11.	IR receiver	Receiver for IR signal from remote control
12.	Rear intake vent	Rear cooling intake – do not obstruct
13.	Exhaust vent	Exhaust vent – do not obstruct
14.	Kensington lock	Attach the projector to a permanent object with the Kensington slot and a security cable.
15.	Security chain lock	Attach the projector to a permanent object using a security cable.
16.	Carrying handle	Pull up the handle when carrying the projector.

Important:

Grill openings on the projector allow for good air circulation, which keeps the projector lamp cool. Do not obstruct any of the grill openings.

Bottom view

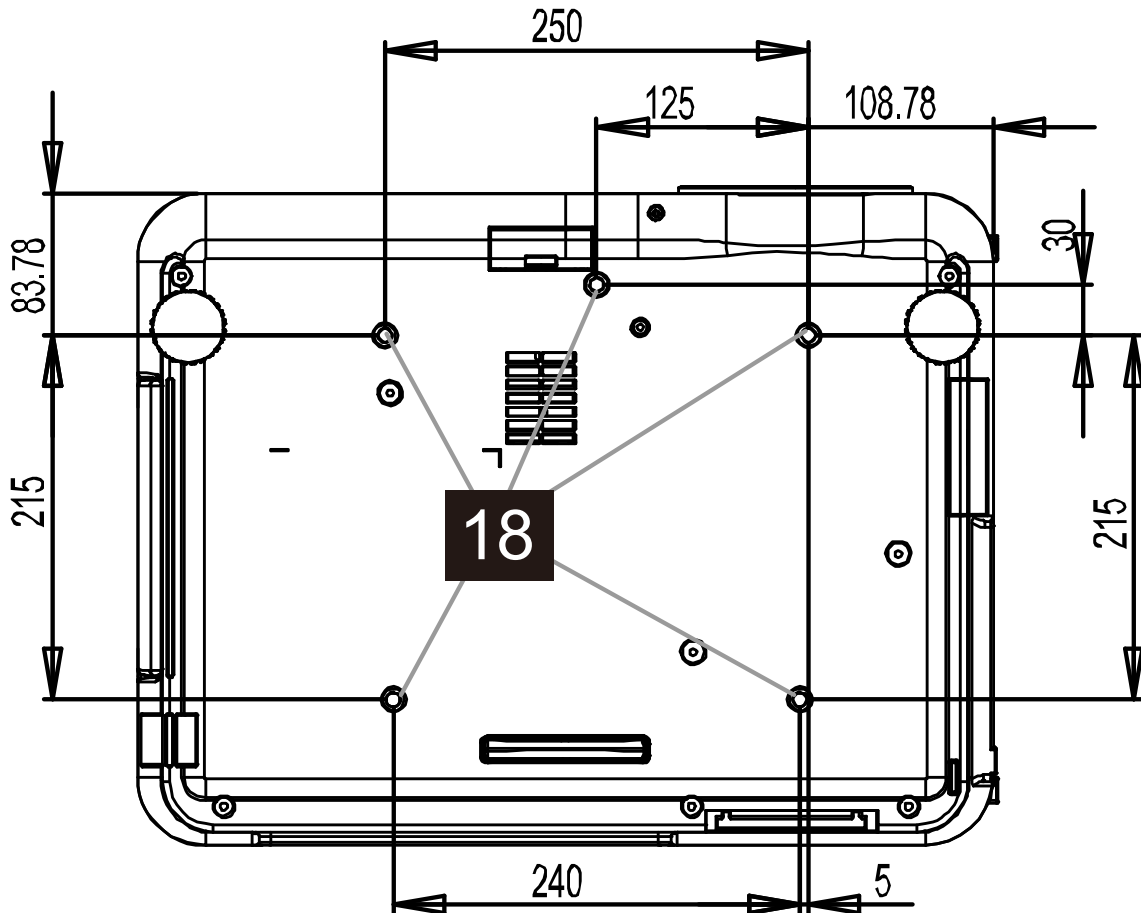

ITEM	LABEL	DESCRIPTION
18.	Ceiling support holes	Contact your dealer for information on mounting the projector on a ceiling

Note:
 When installing, ensure that you use only UL Listed ceiling mounts.

Caution:
 With ceiling installation, use approved mounting hardware & M4 screws; maximum depth of screw: 12 mm; distance from ceiling/ wall: 20 cm (0.7 feet) for proper ventilation; distance from fluorescent lamps: at least 1 m (3 feet) front and back of the projector. For permanent installations, follow local codes.

Top Features

OSD Controls and Status LEDs

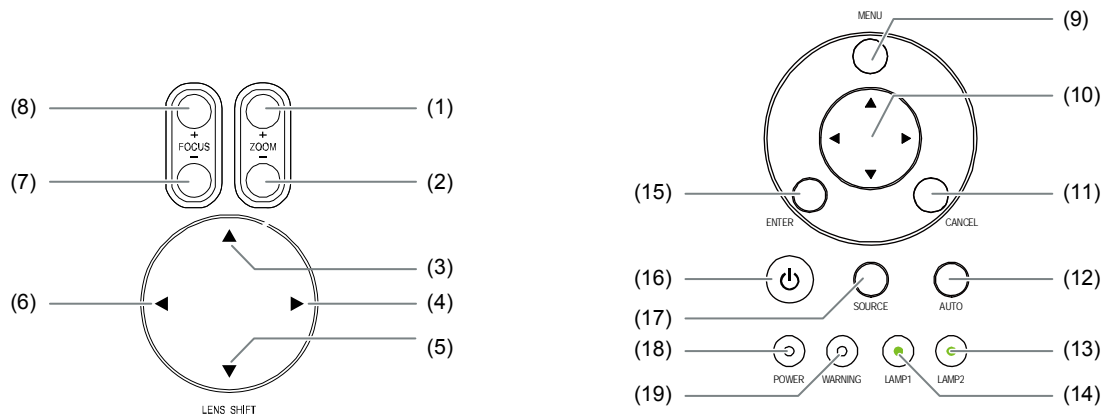

ITEM	LABEL	DESCRIPTION
1.	ZOOM+	Increase/decrease projected image size
2.	ZOOM-	
3.	UP CURSOR	Move image left, right, up, or down
4.	RIGHT CURSOR	
5.	DOWN CURSOR	
6.	LEFT CURSOR	
7.	FOCUS-	Focus the projected image
8.	FOCUS+	
9.	MENU	Open / Close the OSD
10.	UP/ DOWN/ LEFT/ RIGHT BUTTONS	Navigate and change settings in the OSD
11.	RETURN	Exit the On-Screen Display (OSD)
12.	AUTO	Auto Sync to optimize image size, position, and resolution
13.	LAMP 2 (LED)	Green / Flashing, See Indicator Messages
14.	LAMP 1 (LED)	
15.	ENTER	Select or change settings in the OSD
16.	POWER	Turn the projector on or off (main power switch must be turned on first). Press to place the projector in standby mode.
17.	INPUT	Select the input source
18.	POWER (LED)	Green / Orange / Flashing. See Indicator Messages
19.	STATUS (LED)	Green / Red / Orange / Flashing See Indicator Messages

Terminal Panel Features

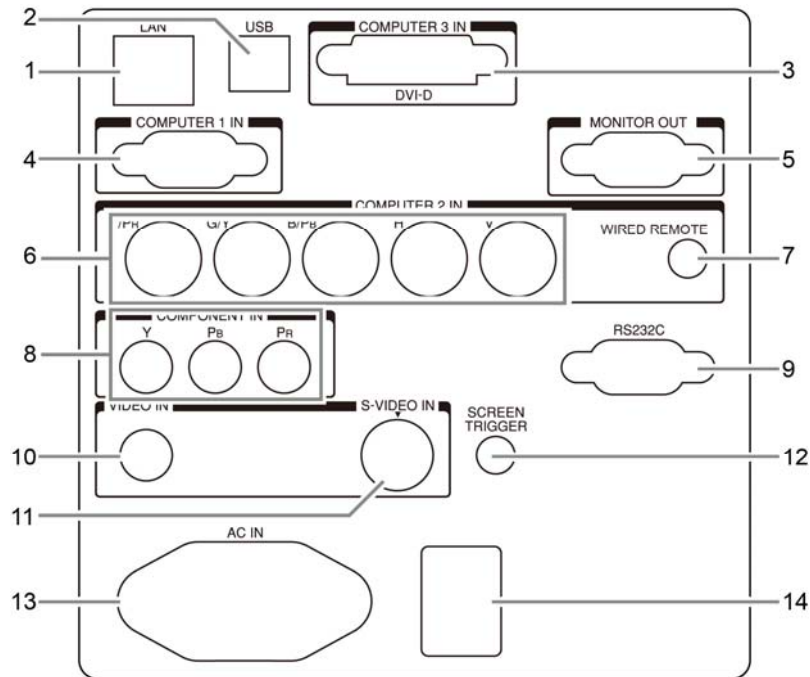

ITEM	LABEL	DESCRIPTION
1.	LAN	Connect a LAN cable (not supplied) from a computer
2.	SERVICE	For service personnel only.
3.	COMPUTER 3 IN	Connect the DVI-D cable (not supplied) from a computer
4.	COMPUTER 1 IN	Connect a VGA cable (supplied) from a computer
5.	MONITOR OUT	Connect to a monitor
6.	COMPUTER 2 IN (R/Cr, G/Y, B/Cb, H, V)	Connect RGBHV or Component signal from computer or component video enabled device
7.	WIRED REMOTE	Connect the remote to the projector
8.	COMPONENT IN (Y, Pb/Cb, Pr/Cr)	Connect a component video enabled device
9.	SERIAL PORT IN	Installation control
10.	VIDEO IN	Connect a composite video cable (not supplied) from a video device to the yellow RCA jack
11.	S-VIDEO	Connect a commercially available S-video cable from a video device
12.	SCREEN TRIGGER	When connected to the screen through a commercially available cable, the screen deploys automatically on start up of the projector. The screen retracts when the projector is powered off (see notes below)
13.	AC IN	Connect the supplied power cable
14.	POWER SWITCH	Turn on/off the projector

Note: Screen Trigger

- When the projector is turned on, a control signal (DC 12V) outputs from this terminal.
- Screen controllers are supplied and supported by screen manufacturers.
- Do not use this jack for anything other than intended use.

Remote Control

Item	Label	Description
	1. Status LED	Lights when the remote control is used
	2. ON	Turn the projector on at standby mode
	3. OFF	Turn the projector off (standby mode)
	4. ZOOM +	Increase the projection image size
	5. ZOOM -	Reduce the projection image size
	6. FOCUS+	Focus the projection image
	7. FOCUS-	Focus the projection image
	8. TEST PATTERN	Navigates and changes settings in the OSD
	9. LENS SHIFT	Adjust lens shift range
	10. UP	Move OSD cursor up
	11. RIGHT	Move OSD cursor right or enter submenu
	12. DOWN	Move OSD cursor down
	13. LEFT	Move OSD cursor right or enter submenu
	14. ENTER	Freeze/unfreezes the on-screen picture
	15. MENU	Display OSD main menu
	16. RETURN	Return to last OSD page or exit menu
	17. INPUT	Select the input source
	18. PICTURE	Display picture menu
	19. NETWORK	Display network setting menu
	20. AUTO	Auto adjustment for phase, tracking, size, position
	21. ASPECT	Set up aspect ratio of the projected image
	22. BLANK	Blank the image or press again to display the imaged.
	23. OVERSCAN	Enable or disable the overscan function
	24. FREEZE	Freeze/unfreezes the on-screen picture
	25. LAMP MODE	Display the Lamp Control menu
	26. 3D MUTE	Open the 3D Mode menu
	27. INFO.	Display the Information menu
	28. LIGHT	Illuminates the buttons on the remote control for 10 sec.
	29. Wire remote jack	Connect to WIRED REMOTE terminal on the projector

Important:

- Avoid using the projector with bright fluorescent lighting turned on. Certain high-frequency fluorescent lights can disrupt remote control operation.
- Be sure nothing obstructs the path between the remote control and the projector. If the path between the remote control and the projector is obstructed, you can bounce the signal off certain reflective surfaces such as projector screens.

Remote Control Operating Range

The remote control uses infrared transmission to control the projector. It is not necessary to point the remote directly at the projector. Provided you are not holding the remote perpendicular to the sides or the rear of the projector, the remote will function well within a radius of about 7 meters (23 feet) and 15 degrees above or below the projector level. If the projector does not respond to the remote control, move a little closer.

SETUP AND OPERATION

Inserting the Remote Control Batteries

1. Remove the battery compartment cover by sliding the cover in the direction of the arrow.

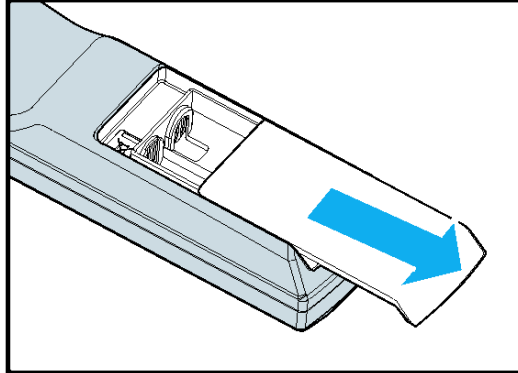

2. Insert the supplied batteries taking note of the polarity (+/-) as shown here.

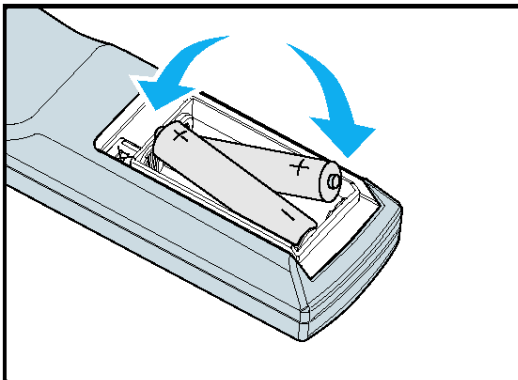

3. Replace the cover.

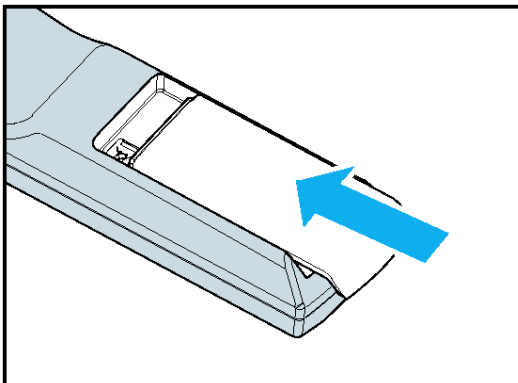

Caution:

- Only use AA batteries.
- Dispose of used batteries according to local ordinance regulations.
- Remove the battery when not using the projector for prolonged periods.

Installing or Removing the Optional Lens

Caution:

- Do not shake or place excessive pressure on the projector or the lens components as the projector and lens components contain precision parts.
- When shipping the projector with the optional lens, remove the optional lens before shipping the projector. The lens and the lens shift mechanism may encounter damage caused by improper handling during transportation.
- Before removing or installing the lens, be sure to turn off the projector, wait until the cooling fans stop, and turn off the main power switch.
- Do not touch the lens surface when removing or installing the lens.
- Keep fingerprints, dust or oil off the lens surface. Do not scratch the lens surface.
- Work on a level surface with a soft cloth under it to avoid scratching.
- If you remove and store the lens, attach the lens cap to the projector to keep off dust and dirt.

Removing the Existing Lens From the Projector

1. Pull out the lens cap.

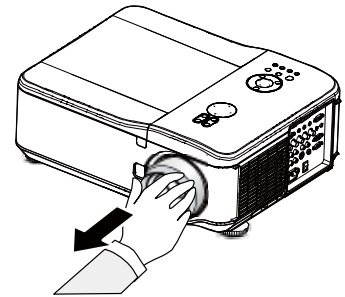

2. Push the LENS RELEASE button all the way in and rotate the lens counterclockwise. The existing lens will be disengaged.

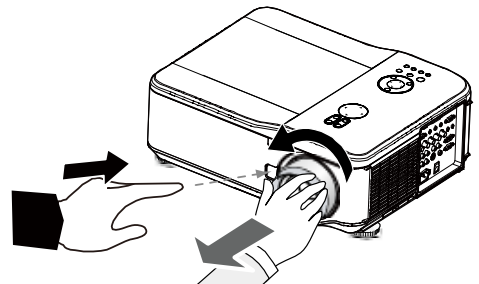

3. Pull out the existing lens slowly.

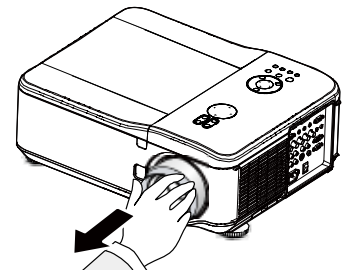

Caution:

When installing the lens into the projector, be sure to remove the lens cap from the back of the optional lens before installing the optional lens into the projector. Failure to do so will cause damage to the projector.

Installing the New Lens

1. Push the LENS RELEASE button and pull in the lens following the arrow mark on the lens slowly.

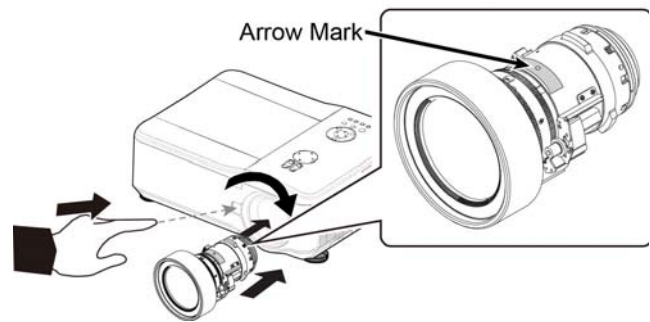

2. Rotate the lens clockwise until it is with two clicks

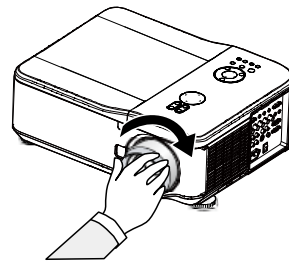

Throw Distance and Screen Size

Example of DX6530 using Standard lens:

The further your projector is from the screen or wall, the larger the image. The minimum size the image can be is approximately 40 inches (1 m) measured diagonally when the projector is roughly 74.1 inches (1.88 m) from the wall or screen. The largest the image can be is 500 inches (12.7 m) when the projector is about 956 inches (24.28 m) from the wall or screen.

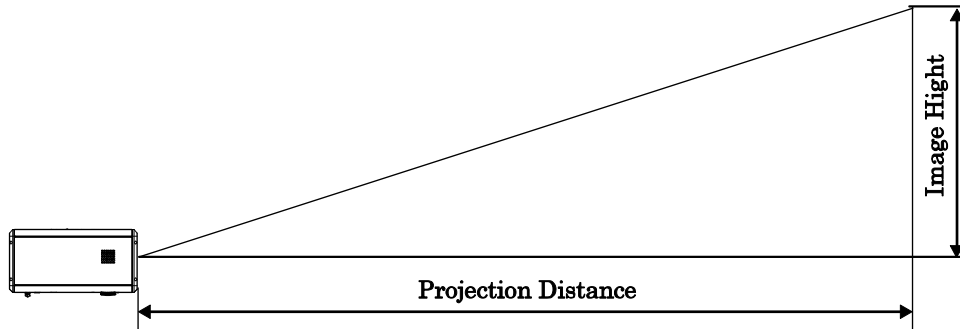

Screen Size						Wide Fix	Wide Zoom	Standard Lens			
Diagonal		Width		Height		0.78	1.28 - 1.85	1.77 - 2.34			
Distance											
inches	m	inches	m	inches	m	inches	m	inches	m		
40	1.02	32	0.81	24.0	0.61	24.5	0.62	40.4 - 58.5	1.03 - 1.49	55.8 - 74.1	1.42 - 1.88
50	1.27	40	1.02	29.9	0.76	31.0	0.79	51.0 - 73.6	1.30 - 1.87	70.4 - 93.2	1.79 - 2.37
60	1.52	48	1.22	35.8	0.91	37.6	0.96	61.6 - 88.8	1.57 - 2.25	85.1 - 112.4	2.16 - 2.86
80	2.03	64	1.63	48.0	1.22	50.8	1.29	82.9 - 119.0	2.11 - 3.02	114.3 - 150.8	2.90 - 3.83
100	2.54	80	2.03	59.8	1.52	63.9	1.62	104.1 - 149.2	2.65 - 3.79	143.5 - 189.1	3.65 - 4.80
120	3.05	96	2.44	72.0	1.83	77.1	1.96	125.4 - 179.4	3.18 - 4.56	172.8 - 227.4	4.39 - 5.78
150	3.81	120	3.05	90.2	2.29	96.8	2.46	157.3 - 224.8	3.99 - 5.71	216.7 - 285.0	5.50 - 7.24
180	4.57	144	3.65	107.5	2.73	116.6	2.96	189.1 - 270.1	4.80 - 6.86	260.5 - 342.5	6.62 - 8.70
200	5.08	160	4.06	120.1	3.05	129.7	3.30	210.4 - 300.3	5.34 - 7.63	289.8 - 380.8	7.36 - 9.67
300	7.62	240	6.10	179.9	4.57	195.5	4.97	316.6 - 451.5	8.04 - 11.47	436.0 - 572.6	11.07 - 14.54
400	#####	320	8.13	240.2	6.10	261.3	6.64	422.9 - 602.6	10.74 - 15.31	582.2 - 764.3	14.79 - 19.41
500	#####	400	10.16	300.0	7.62	327.1	8.31	529.1 - 753.7	13.44 - 19.14	728.5 - 956.1	18.50 - 24.28

Screen Size						Semi-Long Zoom		Long Zoom 1	
Diagonal		Width		Height		2.28 - 3.82		3.67- 5.58	
						Distance			
inches	m	inches	m	inches	m	inches	m	inches	m
40	1.02	32	0.81	24	0.61	71.9 - 121.3	1.83 - 3.08	115.9 - 176.8	2.94 - 4.49
50	1.27	40	1.02	30	0.76	90.7 - 152.4	2.30 - 3.87	146.2 - 222.3	3.71 - 5.65
60	1.52	48	1.22	36	0.91	109.5 - 183.5	2.78 - 4.66	176.5 - 267.9	4.48 - 6.80
80	2.03	64	1.63	48	1.22	147.0 - 245.7	3.73 - 6.24	237.1 - 358.9	6.02 - 9.12
100	2.54	80	2.03	60	1.52	184.6 - 307.9	4.69 - 7.82	297.7 - 450.0	7.56 - 11.43
120	3.05	96	2.44	72	1.83	222.1 - 370.1	5.64 - 9.40	358.2 - 541.0	9.10 - 13.74
150	3.81	120	3.05	90	2.29	278.4 - 463.4	7.07 - 11.77	449.1 - 677.6	11.41 - 17.21
180	4.57	144	3.65	107	2.73	334.8 - 556.7	8.50 - 14.14	540.0 - 814.2	13.72 - 20.68
200	5.08	160	4.06	120	3.05	372.3 - 618.9	9.46 - 15.72	600.6 - 905.3	15.26 - 22.99
300	7.62	240	6.1	180	4.57	560.0 - 930.0	14.23 - 23.62	903.6 - #####	22.95 - 34.56
400	10.16	320	8.13	240	6.1	747.8 - 1241.0	18.99 - 31.52	1206.6 - #####	30.65 - 46.12
500	12.7	400	10.16	300	7.62	935.5 - 1552.0	23.76 - 39.42	1509.5 - #####	38.34 - 57.69

Screen Size						Long Zoom 2	
Diagonal		Width		Height		5.42 - 8.59	
						Distance	
inches	m	inches	m	inches	m	inches	m
40	1.02	32	0.81	24	0.61	169.6 - 271.2	4.31 - 6.89
50	1.27	40	1.02	30	0.76	215.0 - 341.9	5.46 - 8.68
60	1.52	48	1.22	36	0.91	260.3 - 412.6	6.61 - 10.48
80	2.03	64	1.63	48	1.22	350.9 - 554.0	8.91 - 14.07
100	2.54	80	2.03	60	1.52	441.6 - 695.3	11.22 - 17.66
120	3.05	96	2.44	72	1.83	532.2 - 836.7	13.52 - 21.25
150	3.81	120	3.05	90	2.29	668.2 - 1048.8	16.97 - 26.64
180	4.57	144	3.65	107	2.73	804.1 - 1260.9	20.42 - 32.03
200	5.08	160	4.06	120	3.05	894.8 - 1402.2	22.73 - 35.62
300	7.62	240	6.1	180	4.57	1348.0 - 2109.1	34.24 - 53.57
400	10.16	320	8.13	240	6.1	1801.2 - 2816.0	45.75 - 71.53
500	12.7	400	10.16	300	7.62	2254.3 - 3522.9	57.26 - 89.48

Caution:

- Ceiling installation must be done by a qualified professional. Contact your dealer for more information. It is not recommended you install the projector yourself.
- Only use the projector on a solid, level surface. Serious injury and damage can occur if the projector is dropped.
- Do not use the projector in an environment where extreme temperature occurs. The projector must be used at temperatures between 41 degrees Fahrenheit (5 degrees Celsius) and 104 degrees Fahrenheit (40 degrees Celsius).
- Screen damage will occur if the projector is exposed to moisture, dust or smoke.
- Do not cover the vents on the projector. Proper ventilation is required to dissipate heat. Damage to the projector will occur if the vents are covered.

Installing the Optional Color Wheel

The projector comes with a four-segment color wheel installed. An additional six-segment color wheel is optional. To replace the color wheel (located under the lamp cover adjacent to lamp 1) refer to the following guide.

Note:

Wait until the lamp house and the color wheel cool off.

1. Remove the four screws (A) on the lamp cover.
2. Lift the lamp cover in the direction of the arrow (B).

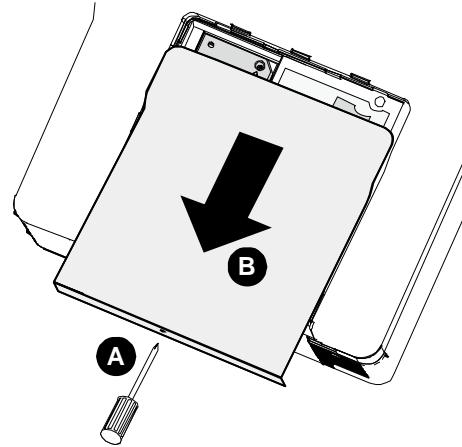

3. Unscrew the retaining screws (x 4) on the four-segment color wheel.

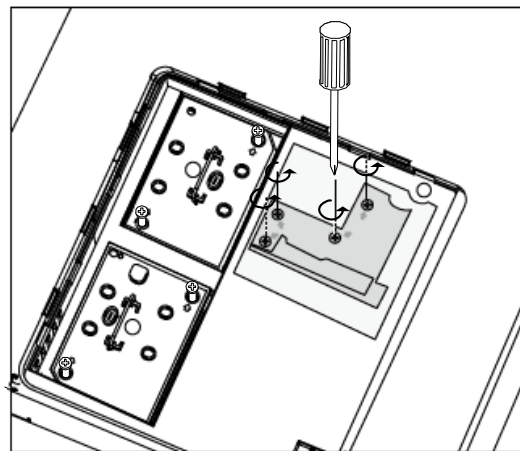

4. Lift the color wheel in the direction shown.

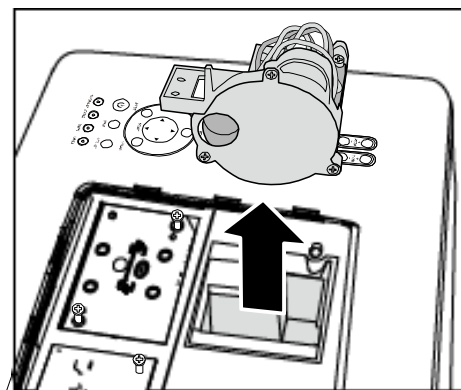

5. Insert the six-segment color wheel

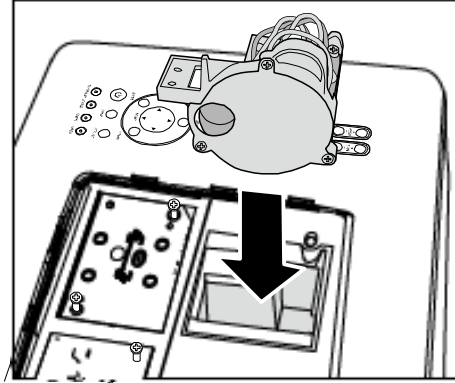

6. Close the lamp cover and secure the retaining screws as shown.

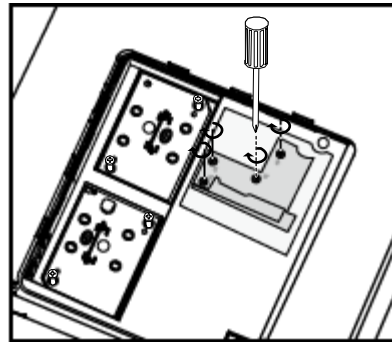

7. Storing Unused Color Wheel:
Keep the unused color wheel in the zipper bag in which the 6-segment color wheel was packaged. This bag prevents dust from falling or collecting on the color wheel

Making Connections

Connecting Your PC or Macintosh Computer

Enabling the computer's external display:

Displaying an image on the notebook PC's screen does not necessarily mean it outputs a signal to the projector. When using a PC compatible laptop, a combination of function keys will enable/disable the external display. Usually, the combination of the **Fn-key** along with one of the 12 function keys activates the external display.

To connect a PC or Macintosh computer to the projector, refer to the following guide.

1. Connect a computer to the projector through one of the three available input data connections before turning on the PC or the projector. The best signal order (from best to least suitable) is as follows:
 - Computer 3 in (see Terminal Panel Features on page 5) is a digital signal and offers the best connection to your computer.

Note:

The DVI (DIGITAL) connector (COMPUTER 3) accepts VGA (640 x 480), SXGA(1152 x 864), XGA (1024 x 768), SXGA (1280 x 1024@up to 60Hz) and UXGA(1600 x 1200 @ 60Hz), please refer to Compatible Input Signal List

- Computer 2 in (see Terminal Panel Features on page 5) is an analog signal; use a DSUB-15 cable-to-5BNC connection.
- Computer 1 in as shown below (see Terminal Panel Features on page 5) is an analog signal that uses a standard RGB computer cable.

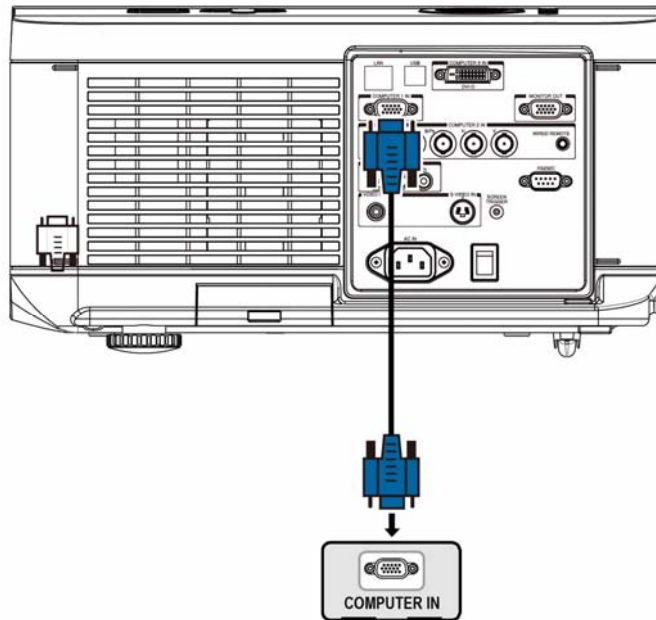

2. Turn on the projector and select the chosen method of connection from the source menu before turning on the PC (see Selecting an Input Source on page 20).
3. Turn on the PC.

Note:

Failure to follow the above steps may not activate the digital output of the graphics card resulting in no picture being displayed. Should this happen, restart your PC.

Connecting an External Monitor

Connect an external monitor to the projector through RGB out connections as shown below (see Terminal Panel Features on page 5).

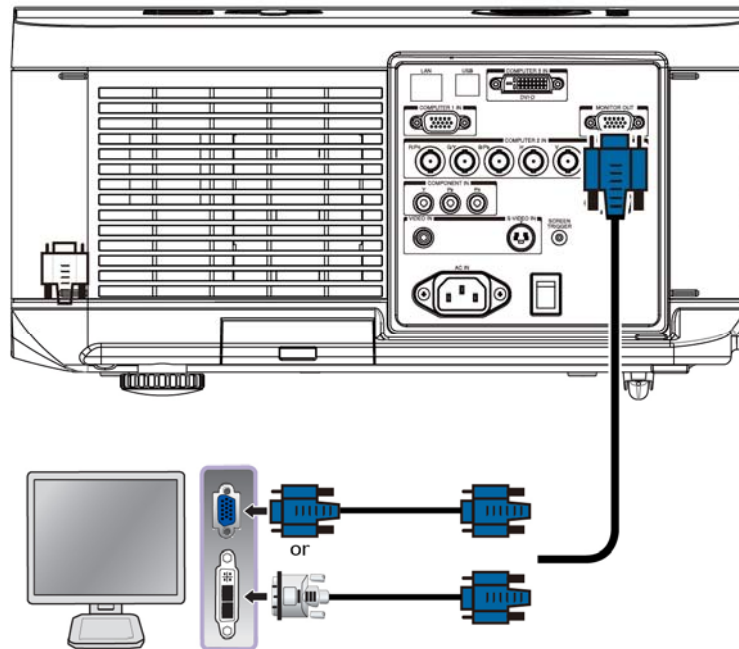

Note:

When projector connects to the external monitor, please make sure Standby Mode is set to Standard .
Monitor Out function works at Standard mode only.

Connecting Your DVD Player with Component Output

To connect a DVD Player to the projector, refer to the following guide.

1. Connect the DVD Player to the projector as shown below before turning on the Player or the projector.

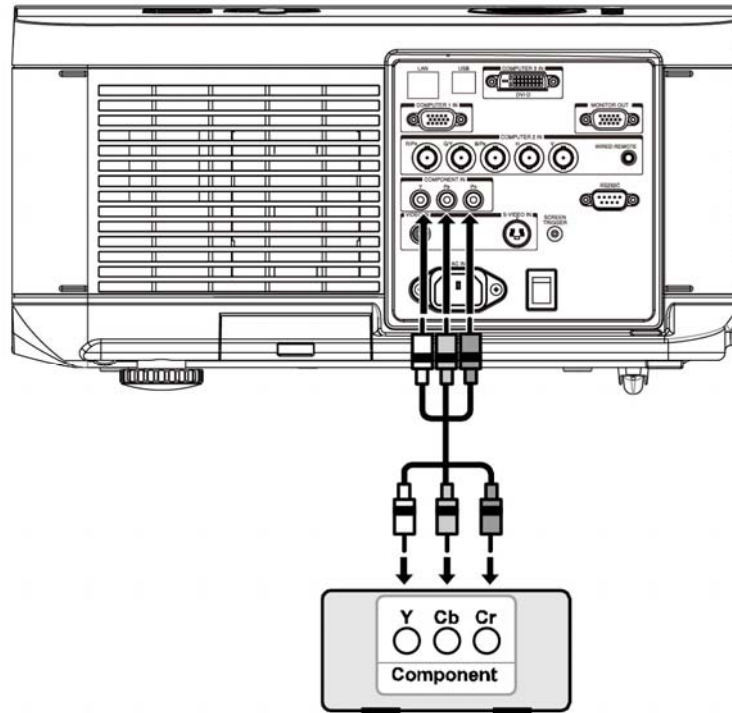

2. Turn on the projector and select **Component** from the source menu before turning on the DVD Player (see [Selecting an Input Source](#) on page 20).
3. Turn on the DVD Player.

Note:

Refer to your DVD player's user's manual for more information about your DVD player's video output requirements.

Connecting Your VCR or Laser Disc Player

To connect your VCR or Laser Disc Player, refer to the following diagram.

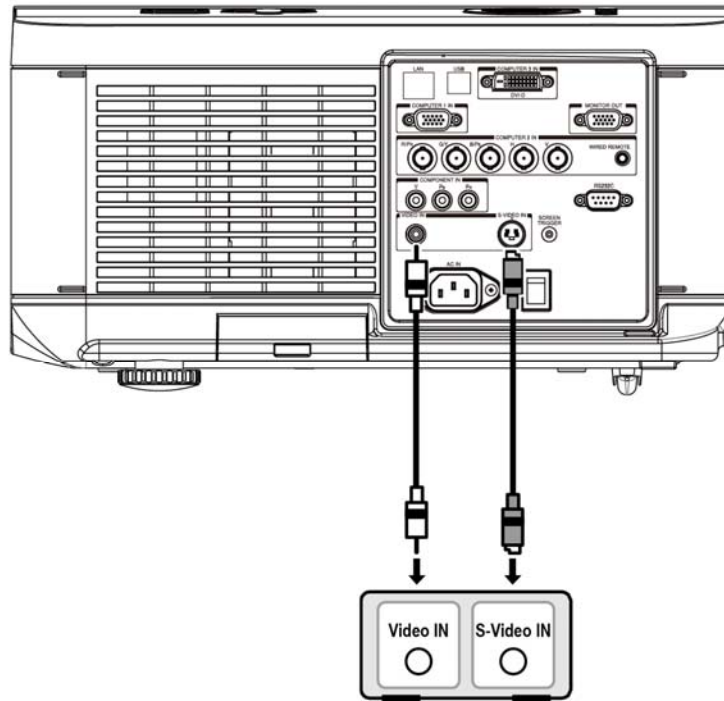

Note:

Refer to your VCR or disc player user's manual for more information about the device's requirements. Images may not be displayed correctly when using an S-Video or Video connection to fast-forward or fast-rewind scanning.

PROJECTING AN IMAGE (BASIC OPERATION)

Turning on the Projector

Once the projector is correctly located and the power cable and other connections are in place, it is important that the projector is powered on correctly in order to avoid damage to components and unnecessary wear and tear. Refer to the following guide to power on the projector.

1. Connect the power cable (A). Press the main power switch to the on (I) position as shown (B). All four LEDs light orange, then the Lamp1 and 2 LEDs turn off and the Warning LED lights green.
2. Press the **POWER** button on the control panel or ON button on the remote control once, the Power LED flashes green and the internal cooling fan starts.
3. After approximately 10 seconds, the Lamp1 and Lamp2 LEDs light green and the Power LED flashes more rapidly.
4. Once the power LED is lit a solid green, the projector is ready for use.

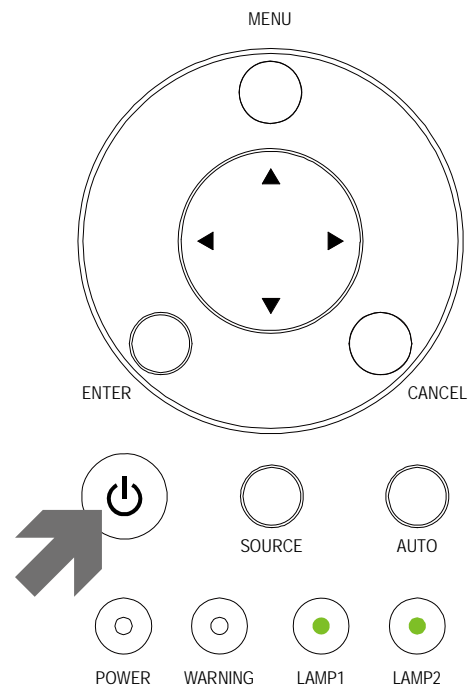
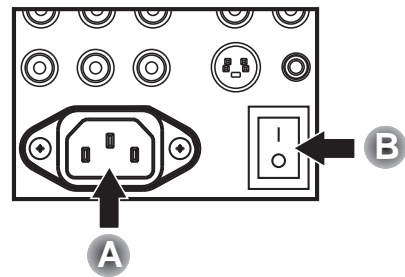

Note:

If any of the LEDs remain flashing or blink there may be a problem with the startup. Please refer to the Troubleshooting section on page 56.

Selecting an Input Source

The Input Source can be selected from the projector's control panel or from the remote control unit. Refer to the following guide to select the Input Source.

1. Press **INPUT** on the control panel or on the remote control unit to display the **INPUT Menu**.

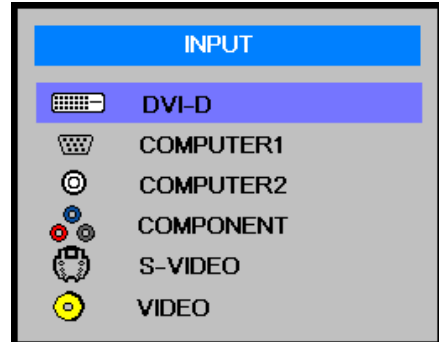

2. Select the required source using ▲ or ▼ and press **←**.

Note:

Return to the projected image by pressing **Cancel** twice.

Adjusting the Picture Position and Picture Size

The Picture Position and Picture Size can be adjusted manually from the lens control panel or from the remote control unit. Refer to the following guides to adjust Picture Position manually.

Adjusting Picture Position Manually

1. Press the **Lens Shift** keypad on the projector in any direction or **LENS SHIFT** button on the remote control to bring up the Lens Shift window.

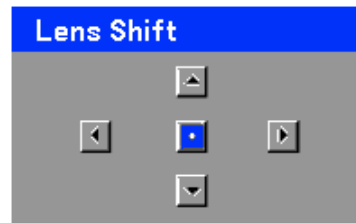

2. Press the directional key as required to shift the image. Releasing the directional arrow will re-center the cursor.

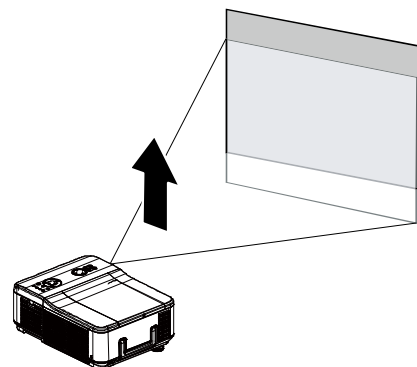

3. To alter the picture size, press **ASPECT** key on the remote control to display **Aspect Ratio** menu.

Press **▲** or **▼** to select the desired picture size then press **◀**.

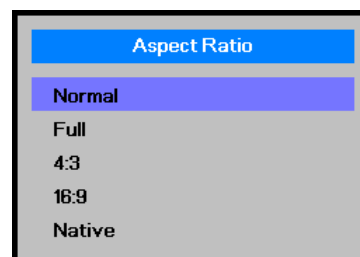

4. If the desired picture sized is selected from menu, press **Menu** and select the **Setup** menu using **◀** or **▶**.

Press **▲** or **▼** to select Aspect Ratio then scroll to the desired picture using **◀** or **▶**.

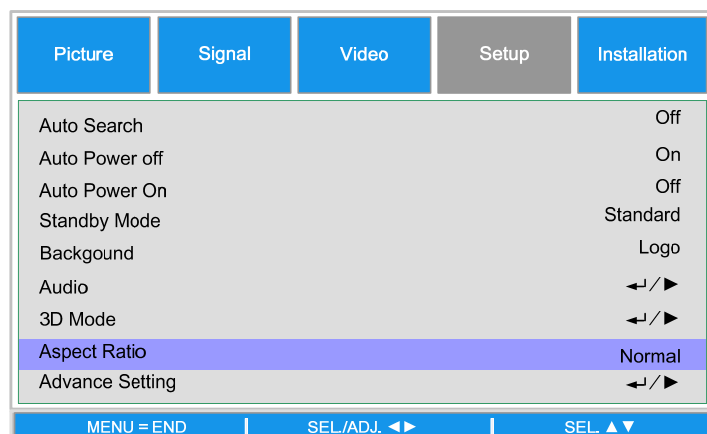

5. When finished, press **RETURN** or **MENU** key to return to the projected image.

Lens Shift Adjustable Range

The adjustable range for lens shift is tabulated below and subject to the conditions listed.

Note:
The drawings below apply to the standard lens only.

Desk-Front Projection

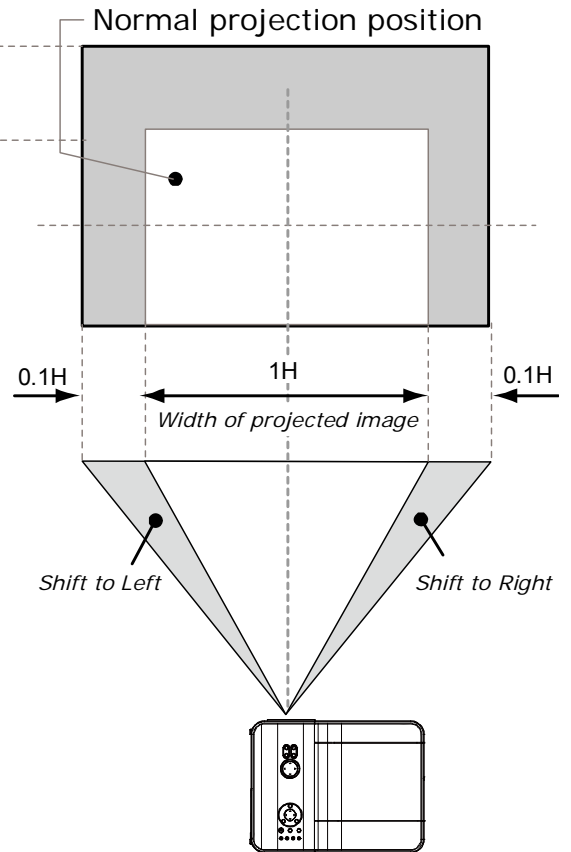
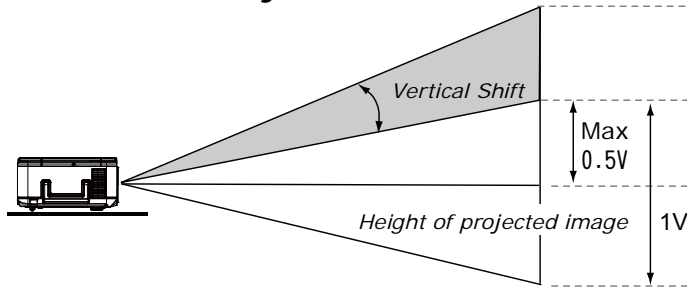

Ceiling Mount-Front Projection

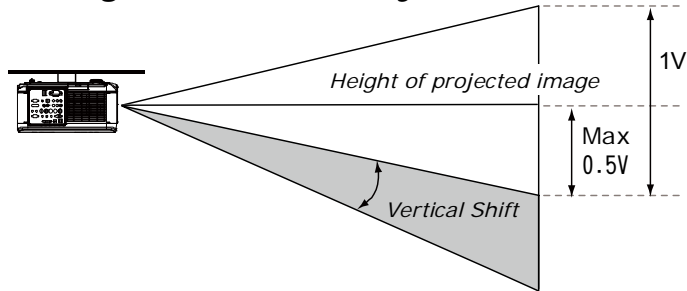

Adjusting the Projector Level

1. To raise the level of the projector, twist the adjusters clockwise.
2. To lower the level of the projector, lift the projector and twist the adjusters counter clockwise.

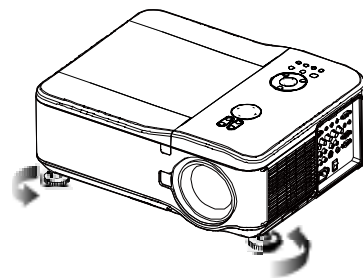
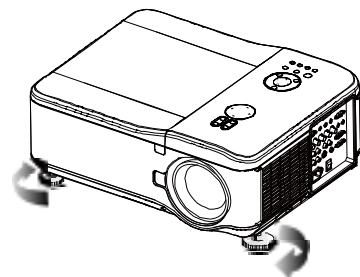

Optimizing an RGB Image Automatically

Adjusting the Image Using Auto Sync

To optimize an RGB image automatically refer to the following guide.

Press the AUTO button on the remote control (see Remote Control on page 6) or the AUTO button on the control panel to optimize an RGB image automatically.

This adjustment may be necessary when you connect your computer for the first time.

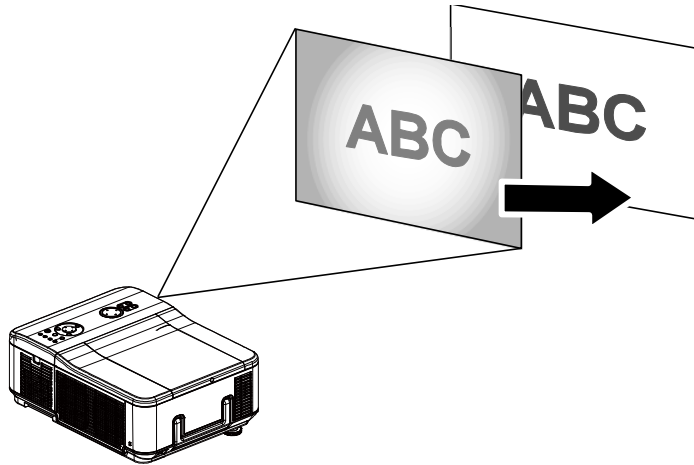

Turning off the Projector

Once the projector is no longer required, it is important to shut it down correctly to avoid damage or unnecessary wear and tear to the projector.

Note:

- Do not unplug the power cable from the wall outlet or projector when the projector is powered on. Doing so can cause damage to the AC IN connector of the projector and (or) the prong plug of the power cable. To turn off the AC power supply when the projector is powered on, use a power strip equipped with a switch and a breaker.
- Do not turn off the AC power supply within 10 seconds of making adjustment or setting changes and closing the menu. Doing so can cause loss of adjustments and settings and return to default.

Refer to the following guide to shut down the projector.

1. Press the **POWER** button on the control panel or **STANDBY** button on the remote control once, the Power Off window displays.

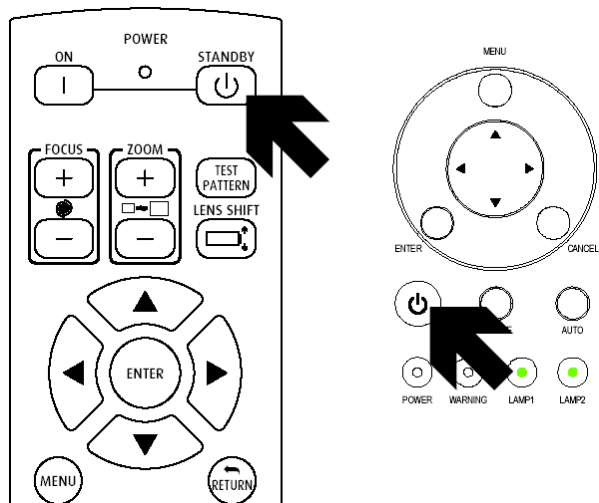

2. Press the **POWER** button again on the OSD control panel or remote control to verify power off. The cooling fans continue to operate (cooling-off time) and the power LED flashes orange. The cooling fans stop operating when the projector turns off.

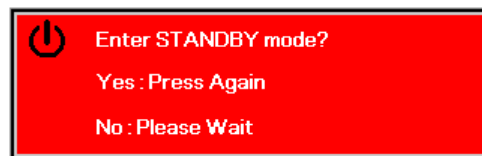

3. The projector enters Standby mode when the power LED lights orange and the warning LED lights green.
4. Press the Main Power switch to the off position (O) to turn off the projector.

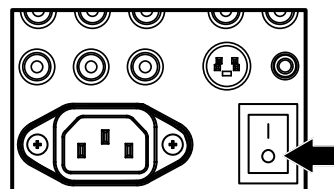

About Direct Power Off

The projector has a feature called "Direct Power Off". This feature allows the projector to be turned off (even when projecting an image) using a power strip equipped with a switch and a breaker.

Note:

Before using Direct Power Off, be sure to allow at least 20 minutes immediately after turning on the projector and starting to display an image.

After Use

Preparation: Make sure that the projector is turned off.

1. Unplug the power cable.
2. Disconnect any other cables.
3. Return the height adjusters to their original, minimum position.
4. Cover the lens with the lens cap.

CONVENIENT FEATURES

Freezing a Picture

The projected image can be frozen for short periods of time by using the remote control. This feature is useful for capturing still images from movies or freezing an animation at a particular point. To freeze the projected image, refer to the following guide.

1. Press the **FREEZE** button on the remote control once (see Remote Control on page 6).
2. The screen freezes.
3. To resume, press the **FREEZE** button once more.

Note:

For extended periods of time it is recommended that the projector be powered off.

Adjusting the Focus/Zoom Manually

The focus and zoom can be adjusted manually from the projector control panel or remote control. Refer to the following guides to adjust the focus and zoom manually.

Press the **Focus** or **Zoom** button on the control key panel or remote control to adjust the Focus/Zoom using the increase and decrease buttons as required.

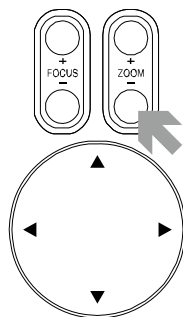

Control Panel

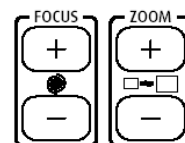

Remote Control

Changing Lamp Mode

The projector has two lamp modes available, **Normal** and **Eco**. The **Normal** mode is used for every-day standard projection, whereas the **Eco** mode is used for saving power and lamp life. To change the Lamp Mode, refer to the following guides.

Changing Lamp Mode by Using the Projector's OSD Control Panel

1. Press **MENU** on the projector's OSD control panel or on the remote control to display the **main** menu. Use ◀or▶ to select Installation menu
2. Use ▲or▼ to select Lamp mode and ◀or▶ to set to Normal or Eco mode.

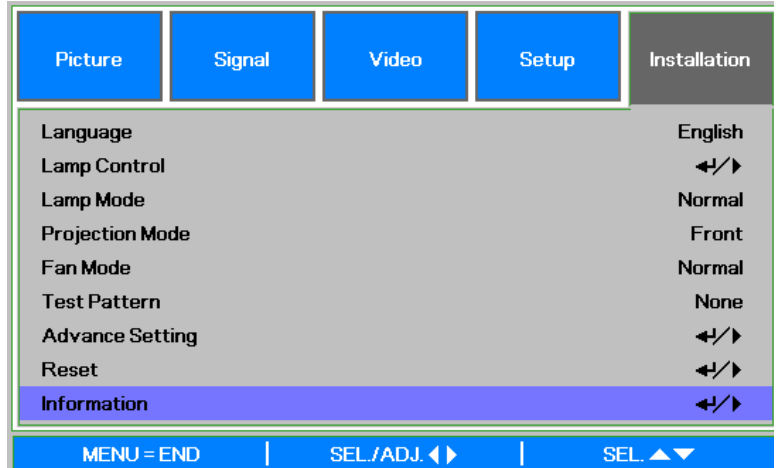

Note:

When the projector is in Eco mode, brightness may be affected.

Normal Mode: 100% Brightness

Eco Mode: approx. 85% Brightness

Getting Information

The Information screen provides details on the life of consumable items within the projector as well as other information such as software version. To access the Information screen, refer to the following guide.

1. Press **Menu** on the projector's OSD control panel or remote control to display the **Main Menu**. Scroll to the **Installation\Information** menu using ▲or▼ and press ◀.
2. The **Information** menu is displayed as the default view. The menu items in this screen are for display and cannot be modified
3. Press **Cancel** or **Menu** to return to the projected image.

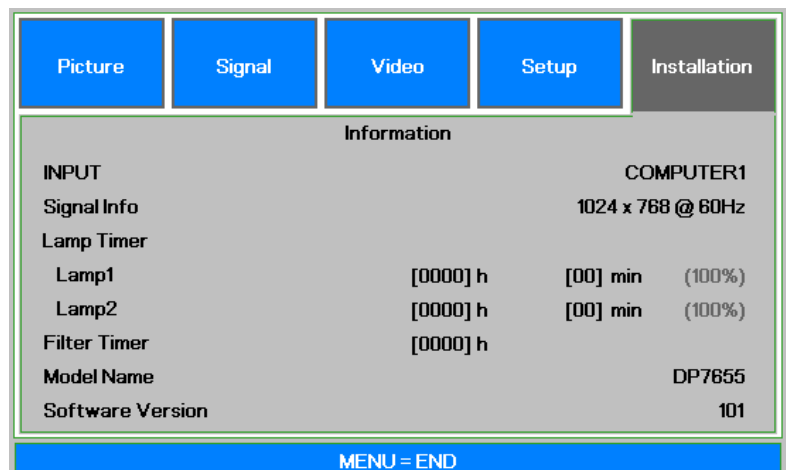

Correcting Keystone by Using the Remote Control

Important:

- When adjusting the keystone, use Lens Shift to set the lens to center.
- The adjustable vertical keystone range is Max. $\pm 30^\circ$ approx.

The following are conditions under which the maximum angle is achieved:

- When the standard lens is used
- When the lens shift is set to H for center and V for 0.5 shift.
- When the lens shift is used and yet you do not get the above-mentioned condition (H for center and V for 0.5 shift), you cannot adjust the lens shift correctly.
- Image is projected in Wide mode

1. Use **▲** or **▼** to select to **Installation\Advance Setting\ Keystone**.

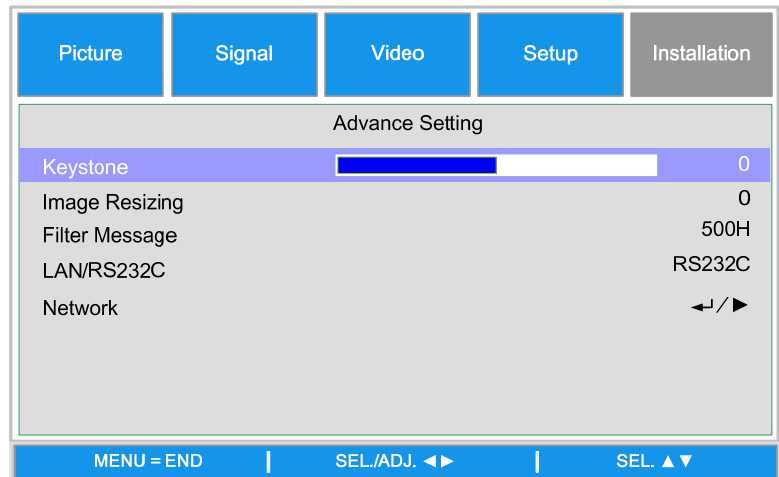

2. Adjust the Keystone sliding bars using the **◀▶** buttons till the screen trapezoid is a regular shape (see diagram).

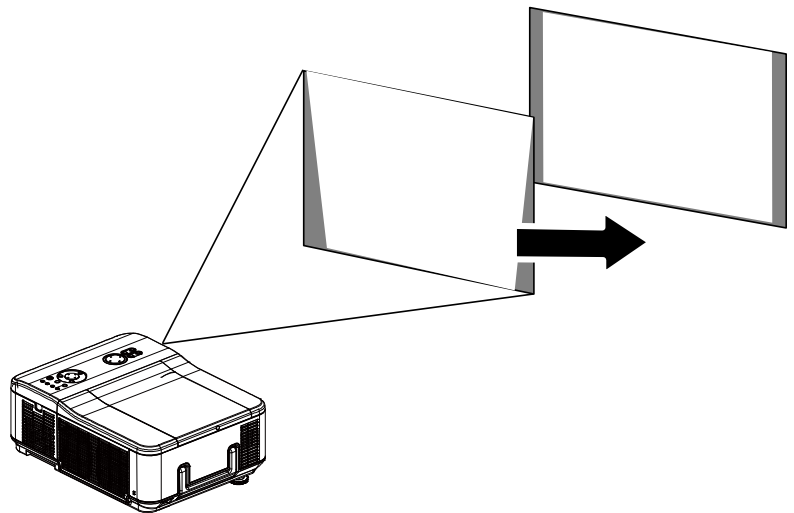

3. Press **Cancel** or **Menu** to return to the projected image.

Preventing the Unauthorized Use of the Projector

The projector has a built-in security feature to lock the OSD control panels and deny remote control operation. The security feature has no default keyword; in the first instance of enabling the security feature, the user must define a keyword.

Locking the Projector

To setup the security keyword, refer to the following guide.

1. Press **Menu** on the OSD control panel on the projector or remote control to display the **Main** menu.

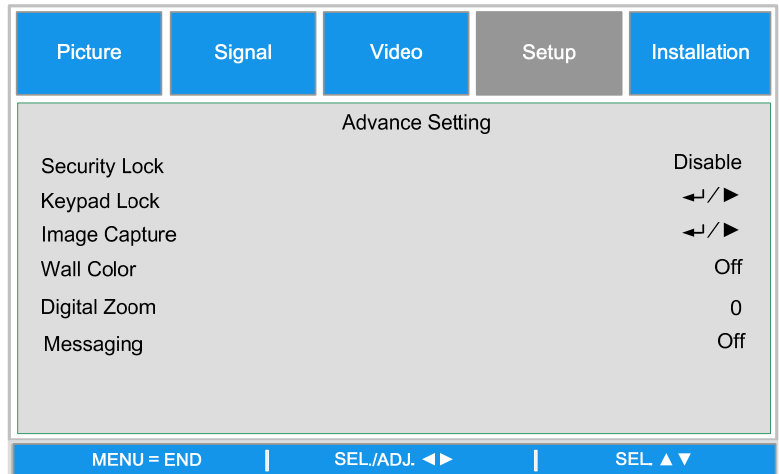

2. User arrow keys to select Security Lock under Setup\Advance Setting menu.

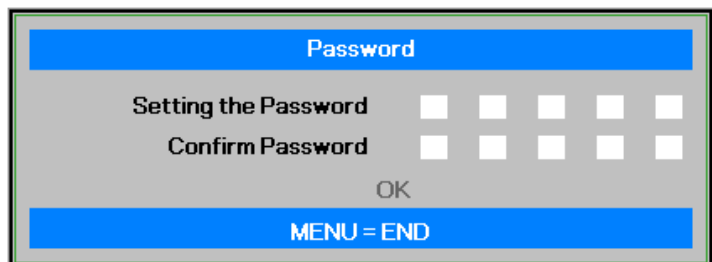

3. Enter the password by remote control key and press ◀ to perform Security Lock function
4. The PIN code window is displayed. Enter a PIN code using ▲▼◀▶. The PIN code characters change to “*”. Press ◀.

Caution:

When you have set or changed the password, take a memo and keep it securely. If you forget your PIN code, the projector can no longer be started. Contact your dealer or the service center.

Unlocking the Projector

To unlock the projector, refer to the following guide.

1. When the projector is locked, either by request during operation or at start up, the locked message is displayed.

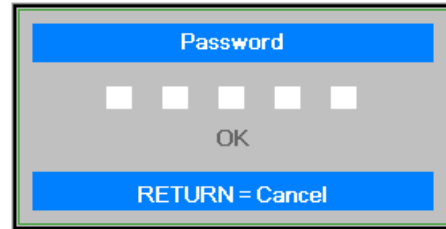

2. To unlock the projector, enter the previously defined PIN code to activate the projector.

Using the Physical Lock

Using the Kensington Lock

If you are concerned about security, attach the projector to a permanent object with the Kensington slot and a security cable.

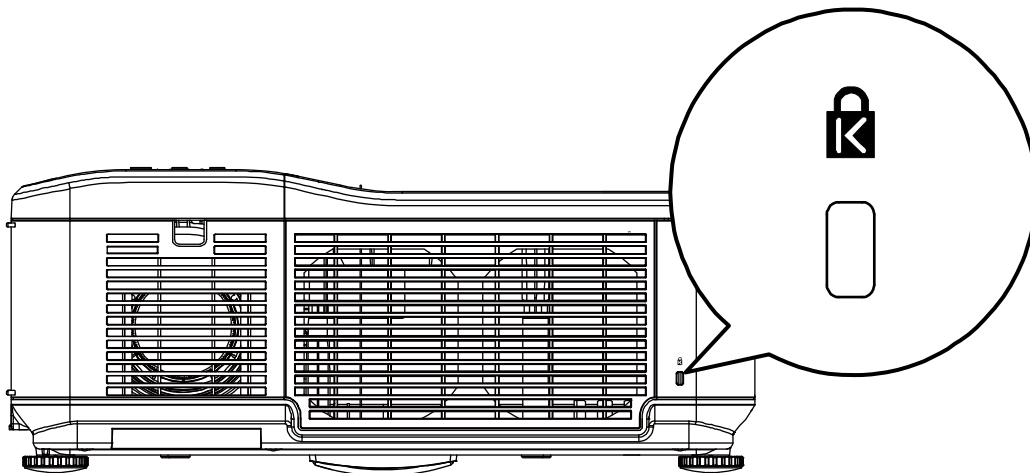

USING ON-SCREEN DISPLAY

Using the Menus

The projector has an On-Screen Display (OSD) that lets you make image adjustments and change various settings.

Navigating the OSD

You can use the remote control or the buttons on the top of the projector to navigate and make changes to the OSD. The following illustration shows the corresponding buttons on the remote control and on the projector.

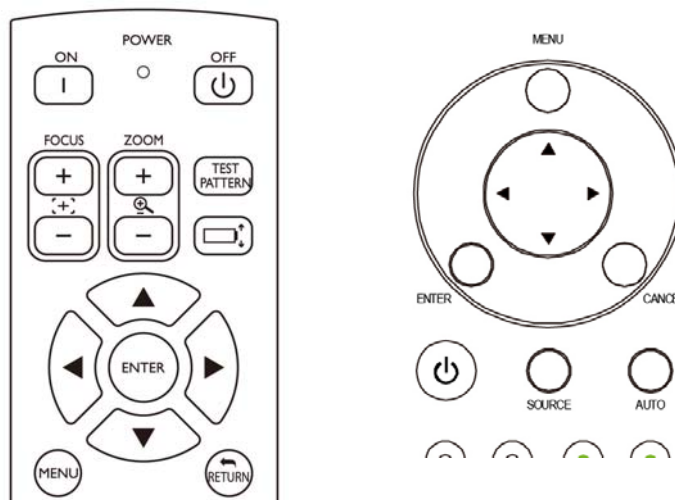

1. To open the OSD, press the **Menu** button on the OSD control panel or remote control. There are six folders on the menu. Press the cursor ◀ or ▶ buttons to move through secondary menus.
2. Press ▲ or ▼ to select menu items and ◀ or ▶ to change values for settings. Press ◀▶ to confirm the new setting.
3. Press **RETURN** to leave a submenu or **MENU** to close menu.

Picture	Signal	Video	Setup	Installation
Language				English
Lamp Control				◀/▶
Lamp Mode				Eco
Projection Mode				Front
Fan Mode				Normal
Test Pattern				None
Advance Setting				◀/▶
Reset				◀/▶
Information				◀/▶

MENU = END | SEL./ADJ. ◀▶ | SEL. ▲▼

Menu Tree

Use the following illustrations to quickly find a setting or determine the range for a setting.

Main Menu	Submenu					
Picture	Picture Mode	Picture Mode				
		Presentation				
		Standard				
		Game				
	Brilliant Color	Brightness				
		Contrast				
		Color				
		Tint				
		Sharpness				
		Advance Setting	Signal Type	Auto		
				RGB		
			YCbCr			
			YPbPr			
		Color Temperature				
	Red					
	Blue					
	Color Manager	R/G/B/C/M/Y		Hue/Saturation/Value		
	Film Mode	Auto/Off				
	Noise Reduction	Level 1/ Level 2/ Level 3/Off				
	Dynamic Black	On/Off				
	Reset	No/Yes				
Signal	Horizontal Position					
	Vertical Position					
	Phase					
	Clock					
	Reset	Yes/No				
	Resolution	Auto/Wide/4:3				
Video	Overscan	On/Off				
	Video System	Auto/PAL/SECAM				
		/NTSC4.3/NTSC 3.58/PAL-M				
	Video Setup	0 IRE/7.5 IRE				
Close Caption	CC1/Off					
Setup	Auto Search	On/Off				
	Auto Power Off	On/Off				
	Auto Power On	On/Off				
	Standby Mode	On/Off				
	Background	Logo/Custom/Blue//None				
	3D Mode	DLP®Link™	On/Off			
		DLP®Link™ Invert				
	Aspect Ratio	Normal/Full/4:3/16:9/Native				
	Advance Setting	Security Lock	Enable/Disable			
		Keypad Lock	No/Yes			
		Image Capture	Save Image	No/Yes		
		Delete	No/Yes			
	Wall Color	Whiteboard/Blackboard/Off				
	Digital Zoom					
	Messaging	On/Off				
Installation	Language	English/Deutsch/Español				
		/Nederlands/Français/Italiano				
		/Svenska/Português/Русский/繁体中文/简体中文/한국어				
	Lamp Control	Both Lamps/Lamp 1 Only/Lamp 2 Only/Auto				

DLP Projector - DX6530/DX6535/DW6030/DW6035 User's Manual

Main Menu	Submenu	
	Lamp Mode	Normal/Eco
	Projection Mode	Front / Rear / Ceiling+Front / Ceiling+Rear
	Fan Mode	Normal / High / UP&Down
	Test Pattern	None/RGB Ramps/Color Bars /Step Bars/Checkboard/Grid /Horizontal Lines/Vertical Lines/Diagonal Lines /Horizontal Ramp /Vertical Ramp/White
	Advance Setting	Keystone Image Resizing Filter Message Lan/RS232C Network
		Off/100H/200H/500H/1000H Lan/RS232C Link DHCP Client IP Address Subnet Gateway DNS Apply 9600bps/19200bps/38400bps
		Connected /Disconnected On/Off No/Yes
	Reset	Communication Speed All Reset Filter Timer Reet
	Information	Input Signal Info Lamp 1 Timer Lamp 2 Timer Filter Timer Model Name S/N Software Version

Input Menu Descriptions and Functions

The **Input** menu displays all supported image sources.

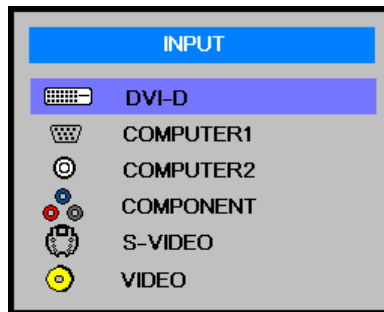

Select the required source from the menu using ▲ or ▼ and press ◀ to confirm.

LABEL	DESCRIPTION
Computer 1	Select the source connected to the Computer 1 input (see Connecting Your PC or Macintosh Computer on page 15).
Computer 2	Select the source connected to the Computer 2 input (see Connecting Your PC or Macintosh Computer on page 15).
Computer 3	Select the source connected to the Computer 3 input (see Connecting Your PC or Macintosh Computer on page 15).
Component	Select the source connected to the Component input (see Connecting Your DVD Player with Component Output on page 17).
Video	Select the source connected to the Video input (see Connecting Your VCR or Laser Disc Player on page 18).
S-Video	Select the source connected to the S-Video input (see Connecting Your VCR or Laser Disc Player on page 18).

Adjust Menu Descriptions and Functions

The **Adjust** menu contains overall projector settings for image output such as picture mode, brightness, color temperature...etc..

Picture

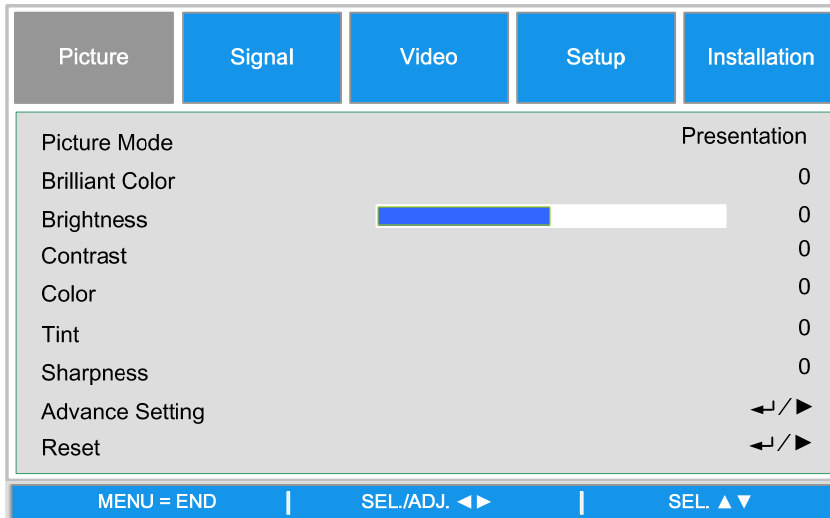

Picture Mode

Select a set of preset values using ◀ or ▶ from the list. Notice that the below values will change depending on the preset selection.

Brilliant Color

Move the slider bar left or right to set the BrilliantColor™ value. BrilliantColor extends the exposure range and sharpens detail for grain free images.

Brightness

Adjust the Brightness value using ◀or▶ to lighten or darken the picture.

Contrast

Adjust the Contrast value using ◀or▶ to highlight the differences between light and dark areas of the picture.

Color

Adjust the Color value using ◀or▶ to increase or decrease color input to the picture.

Tint

Adjust the Tint value using ◀or▶ to increase or decrease the color hue of the picture.

Sharpness

Adjust the Sharpness value using ◀or▶ to sharpen or blur the borders between colors and objects.

Advance Setting

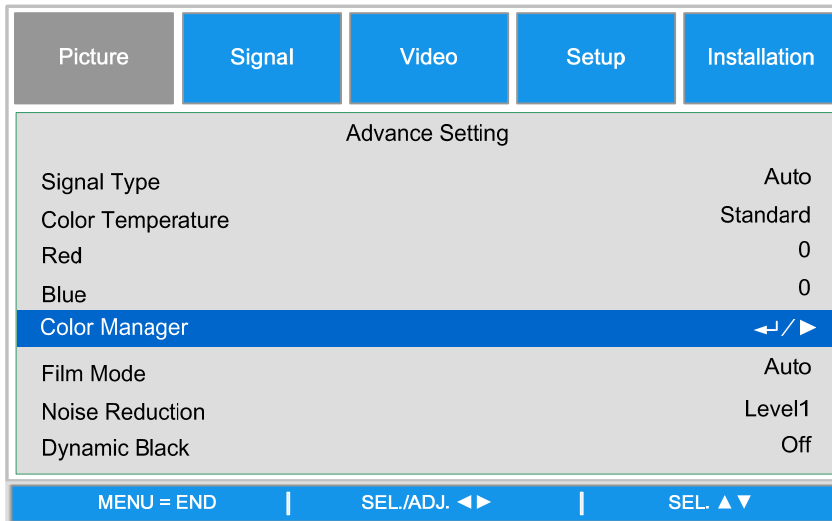

Signal Type

This function allows you to select the input signal from COMPUTER/COMPONENT1,2 or COMPONENT

Auto

Recognize the input signal as RGB or component automatically.

RGB

Set When the input signal is RGB

YCbCr

Set when the input signal is Component(480I/480P/576I/576P).

YPbPr

Set when the input signal is Component signals(720P/1080i/1080p).

Color Temperature

Set the color temperature to Warm, Standard or Cold.

Note:

Color temperature is not selectable when Picture Mode is set to sRGB.

Red

Press ◀or▶ to heighten or weaken red in the image.

Blue

Press ◀or▶ heighten or weaken Blue in the image.

Color Manager

This function allows you to adjust each of the six main colors comprised the color wheel by altering their Hue, Saturation or Value.

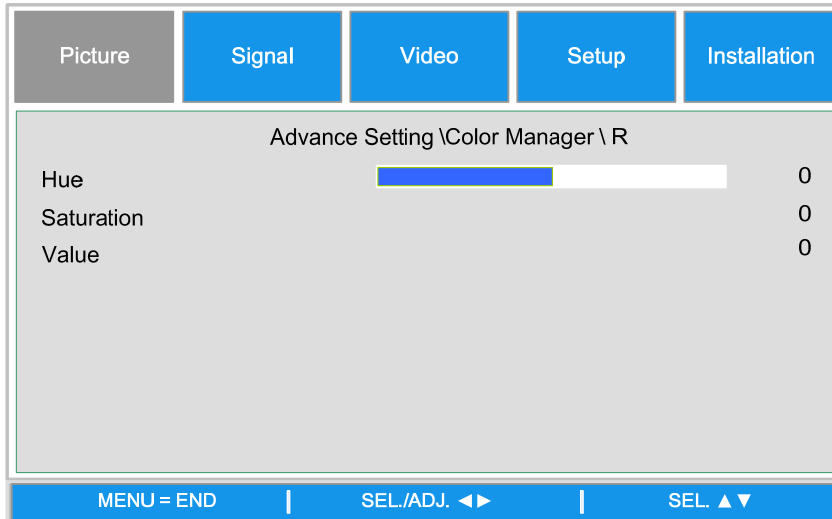

Hue

Use ◀ or ▶ to adjust Hue of the main color as below

Main Color	Hue		
R	Magenta	↔	Yellow
G	Yellow	↔	Cyan
B	Cyan	↔	Magenta
C	Green	↔	Blue
M	Blue	↔	Red
Y	Red	↔	Green

Saturation

Use ◀ or ▶ to adjust Saturation of the main color, the selected color become lighter or thicker.

Value

Use ◀ or ▶ to adjust Value of the main color, the selected color become brighter or darker.

Film Mode

The function provide high-quality playback of image projected at 24fps, such as movies from DVD device.

Auto

Films are detected automatically.

Off : Films are not detected.

Note:

Film Mode is available for below input and signals.

- 480I/576I/1080I from COMPUTER/COMPONENT 1, 2 or COMPONENT INPUT
- All signals from S-Video or Video input

Noise Reduction

This function provides high-quality images with minimal crawl and cross color noise, you can set your preferred level from Off to Level 3 to view a clear image.

Dynamic Black

Set this function as ON to improve the black level of the projected images.

Reset

The settings and adjustments are set to initial factory settings.

Signal Adjustment



Horizontal Position

Move the Image to right or left

Vertical Position

Move the Image to up or down

Phase

Adjust the clock phase or reduce video noise, dot or cross talk

Clock

Fine tune a computer image or remove any vertical banding that might appear.

Reset

Reset all of the changes you made and restore to default settings.

Resolution

This function provides the options to recognize the resolution of the input signal automatically.

- Auto** Recognize the input signal resolution automatically.
- Wide** Set when the wide signal is received.
- 4:3** Set when the wide signal is received

Auto Sync

This function allows you to optimize the image automatically when the projector is turned on or when the input signal is switched or connected from a computer. If Auto Sync is set Off, Auto Sync is not automatically performed.

Note:

Auto Sync may take some time to complete, depending on the image. When the optimum image can not be achieved, please use manual adjustment.

Video Setting

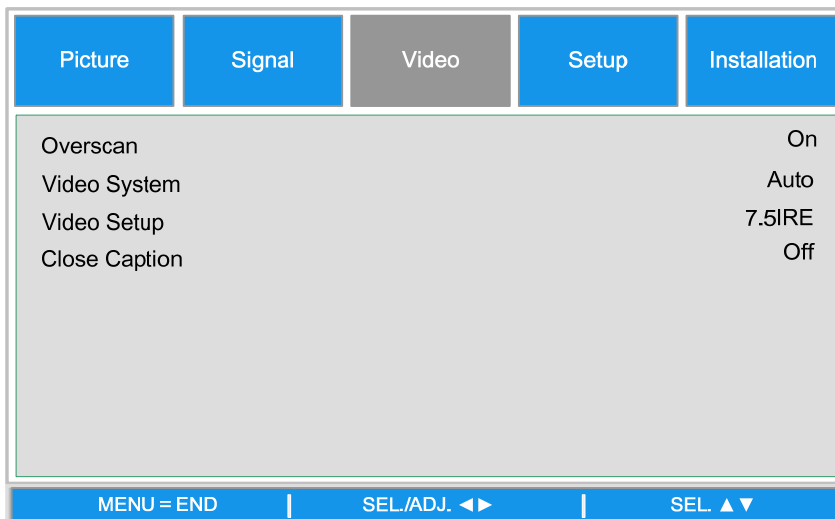

Overscan

The edge of the image may or may not be displayed correctly, this function allows you to set Overscan On to crop the the border area of the image

Note:

The function is available for 480p, 576P, 720p, 1080i and 1080p from COMPUTER/COMPONENT1,2 COMPONENT or DVI-D input

Video System

Set the Video System to Auto unless the projector cannot receive the signal or a clear image, selectable Video signal are Auto, PAL, SECAM, NTSC4.43, NTSC3.58, PAL-M, PAL-N and PAL-60.

Note:

Video System can only be set in Video or S-Video mode

Video Setup

Set the black level to 0 IRE or 7.5IRE.

This function is available for 480I from COMPUTER/COMPONENT 1, 2 or COMPONENT input or NTSC3.58 from Video or S-Video input.

Closed Caption

Set to CC1 or Off as required.

Note:
This function is available in following case

- The signal is NTSC 3.58
- Not all programs and video will offer closed Caption, please make sure they offer Close Caption.

Setup

Picture	Signal	Video	Setup	Installation
Auto Search				Off
Auto Power off				On
Auto Power On				Off
Standby Mode				Standard
Background				Logo
3D Mode				←/▶
Aspect Ratio				Normal
Advance Setting				←/▶

MENU = END | SEL./ADJ. ◀▶ | SEL. ▲▼

Auto Search

This function enables the projector to detect the input signal and to switch the input mode automatically when the project is turned on. Set it to On to enable Auto Search function or Off to disable it.

Auto Power Off

This function enables the projector to enter standby mode automatically when no input signal is detected more than 15 minutes. Set the function to On to enable Auto Power off or to Off to disable it.

Auto Power On

This function enables the projector to be turned on automatically when the power cord is plugged into the AC outlet or the breaker switch is turned. Set the function to On to enable this function.

Note
This function is activated by below conditions

- The Main Power switch on the projector has to be switched to On
- The projector should be turned off by unplugging power cord or the breaker switch directly, Auto Power On will be activated next time when you plug in the power cord or turn on breaker switch

Standby Mode

Standby Mode allows you to put the projector in the standby condition to consume less power, two standby modes are selectable as below.

Standard: Monitor out, LAN/RS232C and Network functions are activated in standby mode

Eco : Monitor out, LAN/RS232C and Network functions are switched in standby mode

Note:

The HTTP server functions, MONITOR OUT and RS232C Control are not available when Standby Mode is set to Eco, please make you the settings before using above functions.

Background

Background enables you to display a blue/black screen, Logo or captured image when there is no signal.

3D Mode:

The 3D mode of this projector is compatible with the DLP®Link™ system. To watch 3D images, you need a pair of 3D LCD shutter glasses that display the projected images for the left and right eyes alternately and are synchronized with a control signal transmitted from the lens of the projector.

Before viewing 3D images, press 3D MODE buttons on the remote control or use arrow keys to display 3D Mode menu for setting 3D mode.

Note:

- The following people should limit 3D viewing:
 - Children under 6 years of age
 - People with a history of photosensitivity, heart disease or in poor health.
 - People who are physically tired or sleep deprived.
 - People under the influence of drugs or alcohol.
- Under normal condition, view 3D images is safe. However, some people may experience discomfort. Refer to the guideline issued by the 3D Consortium revised Dec. 10, 2008, You need take regular breaker at least 5 to 15 minutes after ever half of hour or one hour.

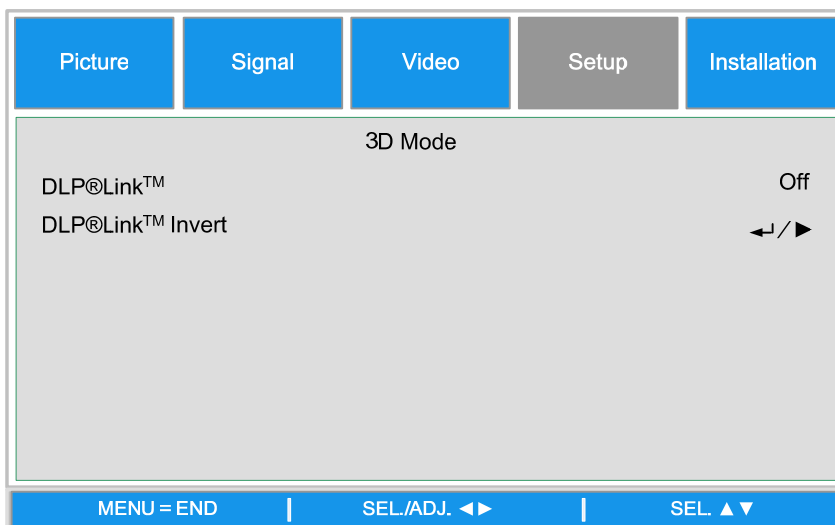

DLP®Link™

Set DLP®Link™ On to view 3D content, Off to ending 3D projection.

Note:

When DLP®Link™ is set to on, Keystone, Aspect Ratio and Image Resizing may not work fully or may not be available.

DLP®Link™ Invert

Set the video for your left and right eyes

Note:

- For viewing 3D image, the source device should support the field sequential format.
- If the projector, 3D playback device or 3D LCD glasses are not set properly, you may experience eye strain and not be able to view the image in 3D.
- For better signal receiving, recommend to view 3D images in front of the screen directly as much as possible. See the operation manual of your 3D LCD glasses.

Setup\Advance Setting

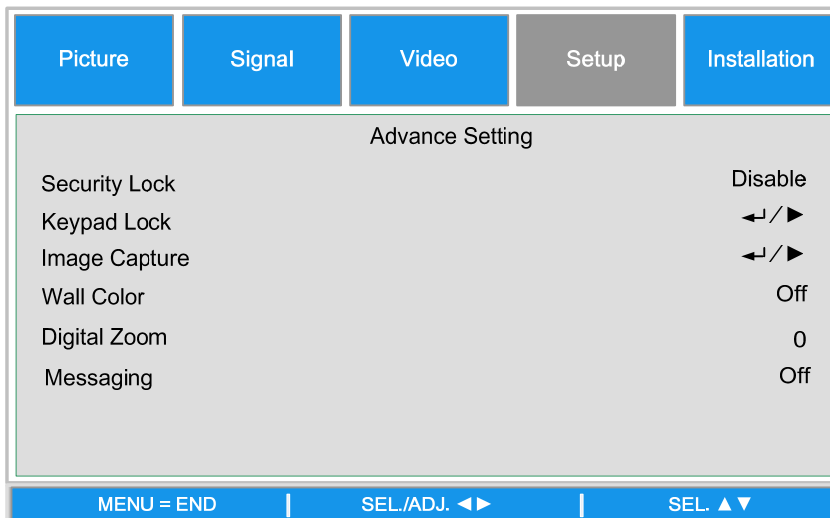

Security Lock

The function allows you to prevent unauthorized use of the projector. Once the function is activated, user must enter the password each time when project is turned on.

Note:

- Password must be recorded in a safe place where only authorized users have access.
- If you lose or forget the password, please contact Vivitek Authorized Dealer or Service Center

Keypad Lock

To prevent unauthorized operation by projector control panel, use this function to lock the buttons on the projector.

No: Turn off the Keypad Lock Function

Yes: Lock All of buttons on the projector except ON/STANDBY button.

Unlock the keypad: Hold down ▼ on the projector control panel for about 5 sec.

Note:

- Keypad Lock cannot be released if the project is under below status
 - Menu is displayed
 - Projector is at standby mode
 - The projector is during warming up
 - Input signal is changing or Auto Sync function is operation.
 - Freeze function is operated.
 - Security Lock window is displayed.
- This Control Panel Lock does not affect the remote control functions.

Image Capture

This function allows you to capture the projected image from RGB signal and set it as a startup image or background image when no signal is detected.

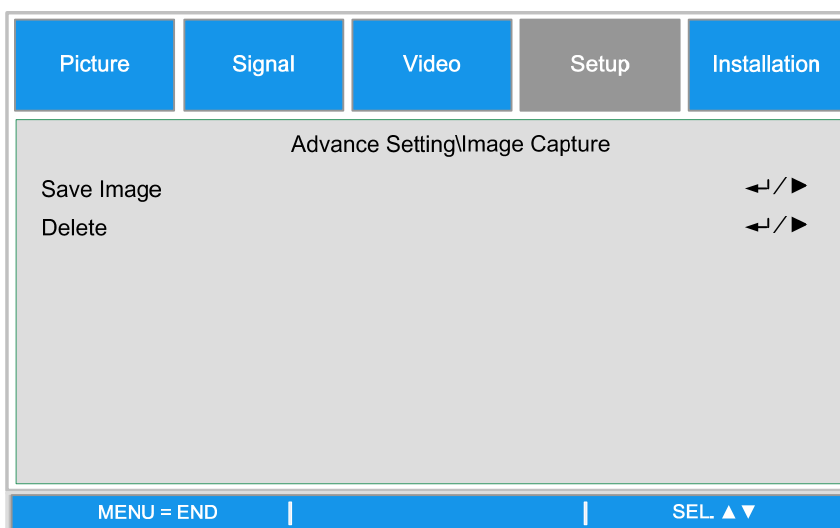

Save Image: Press Enter or ► to capture the desired image and press **Yes** to execute Image capture

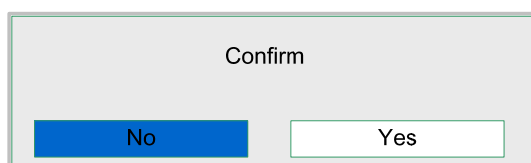

It takes 1 to 2 minutes to complete image capture and shows the progress on the screen.

The message window will be closed after image capture is done.

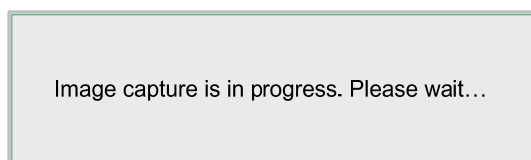

Delete Image

Press Enter or ► and select “Yes” to delete captured image.

Note:

- The image can be captured only when the input source is non-interlace signal from COMPUTER/COMPONENT 1,2 or DVI-D inout, the image from Video or S-Video cannot be captured.
- The captured image must be native resolution such 1280x800 for WXGA, 1024x768 for XGA
- Aspect Ratio must be set to "Normal"
- An image can be captured and saved for either of the four-segment color wheel or six-segment color wheel, each color wheel can save one image.
- Switch the input signal during performing image capture may result in the failure of the capturing

Wall Color

This function allows you to project the image to the colored wall or board without using a screen. Whiteboard: Image is projected to a whiteboard.

Digital Zoom

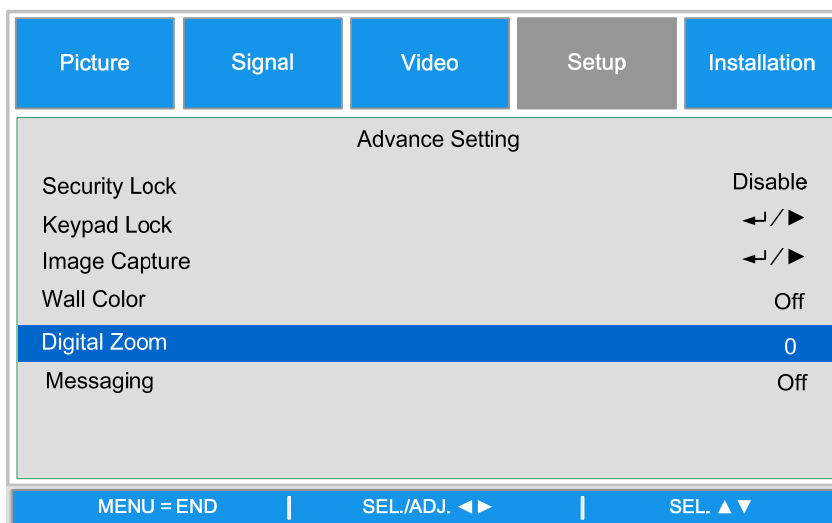

Press arrow key ◀ to reduce the image size or arrow key ▶ magnify the image on projection screen.

Messaging

The function allows you to turn off below message on the projected image, Select On to display the message, Off to hide the message.

- Source Status
- Message of entering standby mode when STANDBY button or Power button is pressed.
- Auto Sync
- Clean the Filter
- Lamp life Warning

Installation

The **Installation** tab contains menu options for various setup conditions such as orientation and remote sensor mode and is accessed through the **Setting** menu.

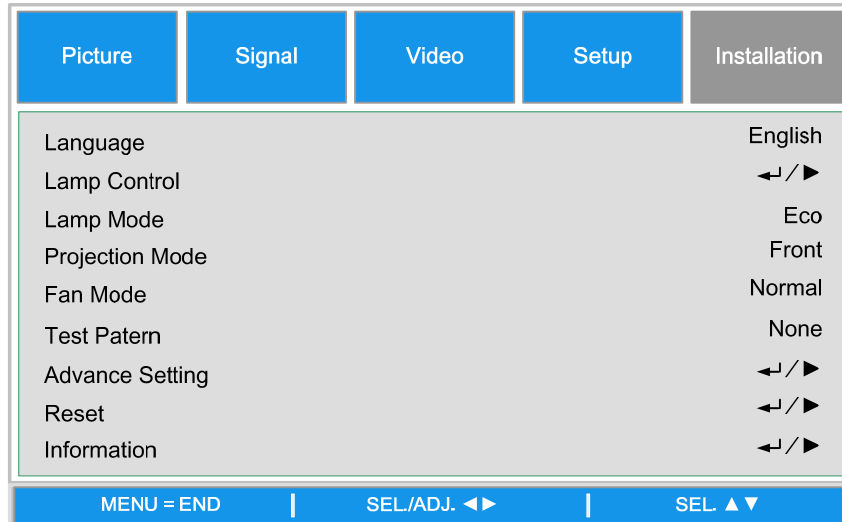

The following table lists all functions with a brief description.

Language

Select the OSD language to be used, eight languages

Lamp Control

This function allows you to select the usage of the two lamps installed in the projector.



Both lamps Both lamps are used for greater brightness

Lamp1 Only Select Lamp 1 for the projector. If lamp 1 burns out, the projector switches the lamp control to lamp2 automatically.

Lamp2 Only Select Lamp 2 for the projector. If lamp 1 burns out, the projector switches the lamp control to lamp2 automatically.

Auto Select the lamp which the usage is lower than the other one

Note: For lamp protection, the lamp switching may take several minutes

Lamp Mode

Select Normal or Eco from the lamp mode window. The lamp life can be extended by using the Eco mode and the fan noise can be reduced.

Projection Mode

Projection Mode enables you to set how the projected image is displayed. Select from the following:

- | | |
|----------------------|--|
| Front | Standard forward facing projection (Default setting) |
| Rear | Standard rear projection. Enables the projector to produce the image from behind the screen by reversing the image |
| Ceiling+Front | Forward facing ceiling mounted projection. Enables ceiling mounted projection by inverting the image. |
| Ceiling+Rear | Rear ceiling mounted projection. Enables ceiling mounted projection from behind the screen by inverting and reversing the image. |

—

Fan Mode

Fan control is used to set the speed of the internal cooling fan according to the installation condition.

- | | |
|----------------|---|
| Normal | Set Fan Speed to Normal if the projector is set up on a table or ceiling mounted at altitudes under 5000 feet/1500 meters |
| High | Set Fan Speed to High if the projector is set up on a table or ceiling mounted at altitudes over 5000 feet/1500 meters |
| UP/Down | Set Fan Speed to Normal if the projector is set up at tilt angle over 10 degree, the fans will run at a high speed. |

Test Pattern

Display a test pattern for installation. The test pattern can be displayed by using ◀ or ▶ or TEST Pattern on the remote control. If using remote control, press ▲ or ▼ on the remote control to select the desired test pattern.

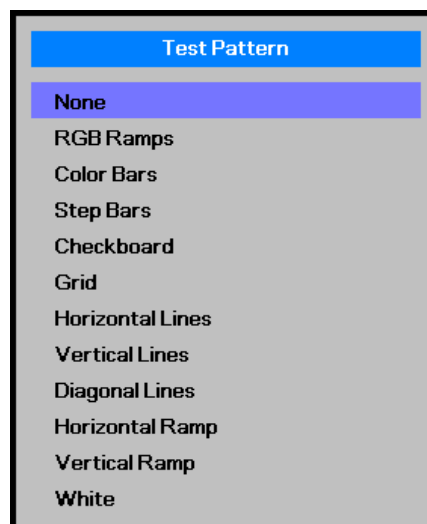

Advance Setting

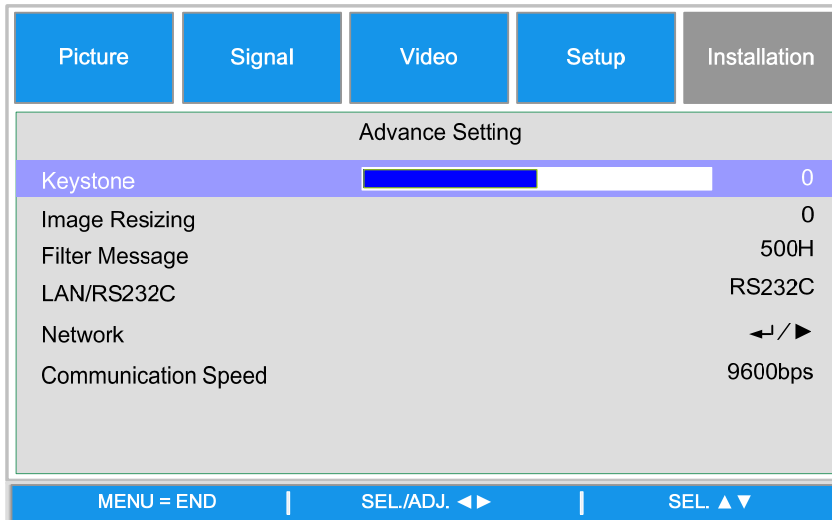

Keystone

When the image is projected either from the top or from the bottom toward the screen at an angle, the image becomes distorted, use Keystone function to correct the distortion, the adjustable range is approximately + 30 degree.

Use ◀ or ▶ button to adjust keystone correction

Image Resizing

When Keystone correction works, the image may be shrunk or enlarged. Use ◀ or ▶ to enlarge or shrink the image vertically

Filter Message: Set the interval time to display a message for cleaning the filter, the selectable options are Off, 100H, 500H and 1000H.

Lan/RS232C

This function enables you to select the path for the projector control

Lan: Control the projector by Lan

RS232C: Control the projector by RS232C.

Note:

The Lan and RS232C control are not available when Standby Mode is set to Eco, please make you the settings before using above functions.

Network

The **Network** menu contains the general LAN settings

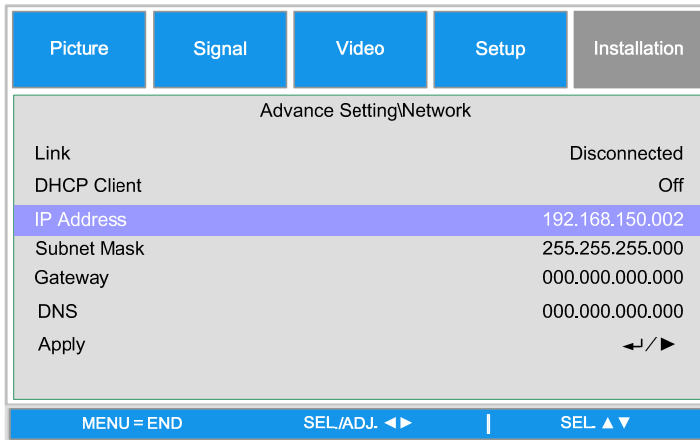

Link

Display the network connection status

DHCP Client

Select either a static IP (Off) or DHCP IP (On) setting by using ◀ or ▶,

On: Enable configuration parameters for IP Address, Subnet Mask, Gateway and DNS automatically.

Off: Set IP Address, Subnet Mask, Gateway and DNS manually.

IP Address

Press ◀ or ▶ to display IP address input window as below, use ▲ or ▼ to change the IP address.

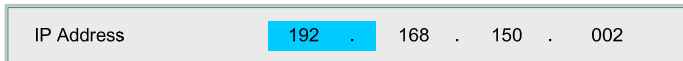

Default setting: 192.168.150.002

Subnet Mask

Set Subnet Mask by Using ◀ or ▶ to select the digit and ▲ or ▼ to change.

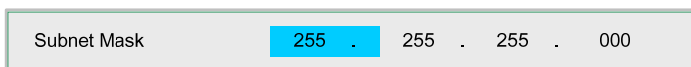

Default setting: 255.155.255.000

Gateway

Set Gateway by Using ◀ or ▶ to select the digit and ▲ or ▼ to change

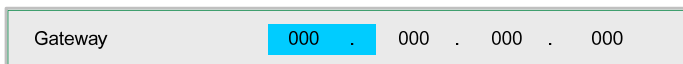

Default setting: 000.000.000.000

DNS

Set DNS by Using ◀ or ▶ to select the digit and ▲ or ▼ to change

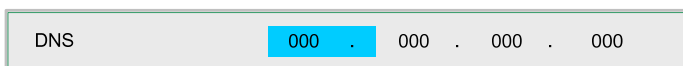

Default setting: 000.000.000.000

Apply

Apply and save settings, please select Yes to apply the settings.

Note:

- Avoid setting an IP address that duplicates the IP Address of other network equipment.
- For details about network setting, consult your network administrator.

Communication Speed

Select communication speed to set the baud rate of the connection.

Select from the following options:

- 9600bps
- 19200bps
- 38400bps

Note:

- Longer cable connections may require lower settings.

Reset

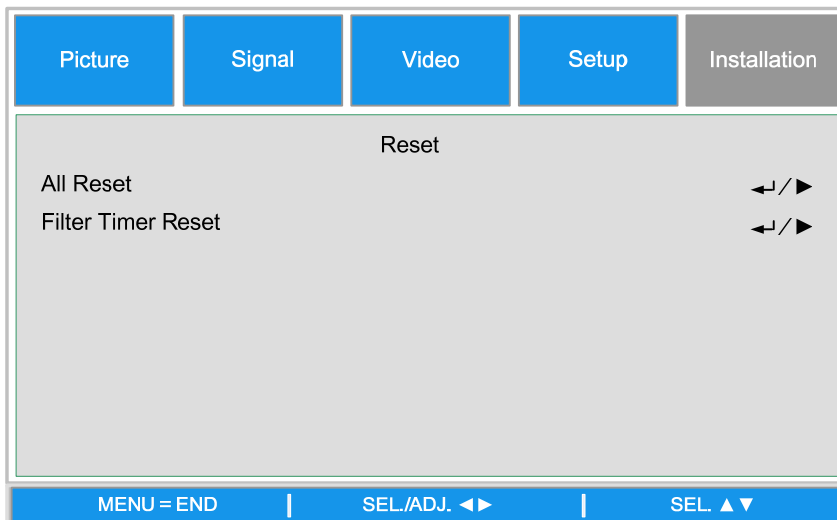

All reset

All reset allows you to initialize the settings you have made in the projector, press Enter or ► to reset the settings.

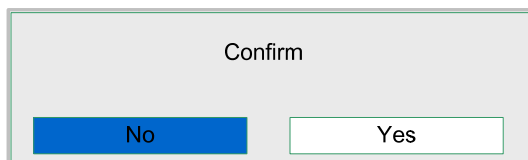

The follow items can not be initialized

- Lamp Timer
- Imaged retained using Image Capture
- Filter Timer

Filter Timer Reset

The function allows you to reset the filter timer, please make sure to reset the timer after cleaning or change the dust filter. Press Enter or ► to display the confirmation message and select Yes to reset the filter timer.

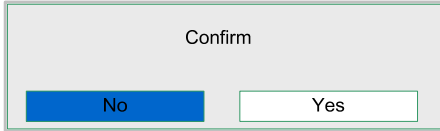

Information

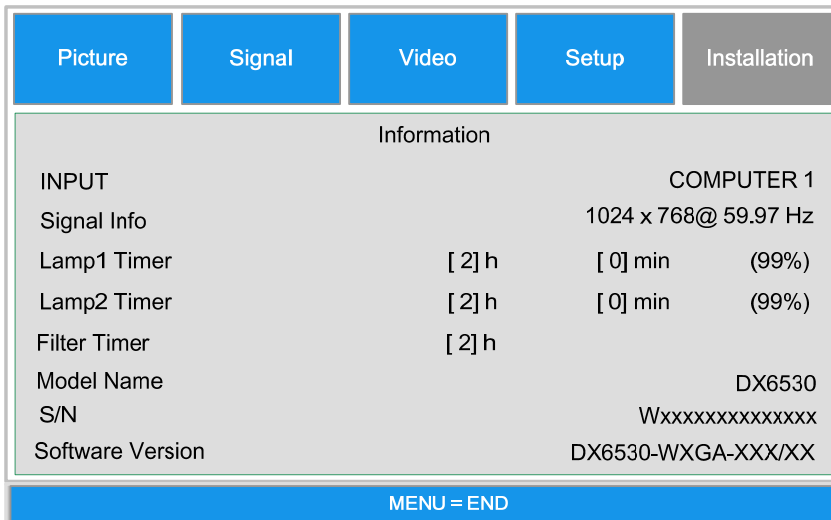

- Input** Current input source
- Signal Info** Current input signal information is displayed
- Lamp timer** Projector counts each lamp usage for reminding the remaining lamp life and usage. The lamp life and remaining are calculated numbers for reference only, actual lamp life may vary with lamp mode, application condition...etc,
- Filter Timer** Current filter usage time counted from last reset you made
- Model Name** The model name is displayed
- S/N** Current serial number is displayed
- Software Version** Current software version is displayed

MAINTENANCE

Cleaning the projector

Cleaning the Cabinet

Refer to the following guide to clean the projector cabinet.

1. Wipe off dust with a clean dampened cloth.
2. Moisten the cloth with warm water and mild detergent and wipe the cabinet.
3. Rinse all detergent from the cloth and wipe the projector again.

Caution:

To prevent discoloration or fading of the case, do not use abrasive alcohol-based cleaners.

Cleaning the Lens

Refer to the following guide to clean the projector lens.

1. Apply a little optic lens cleaner to a clean, lint free cloth (do not apply the cleaner directly to the lens).
2. Lightly wipe the lens in a circular motion.

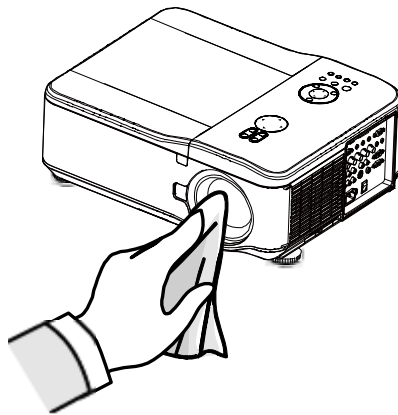

Caution:

- *Do not use abrasive cleaners or solvents.*
- *To prevent discoloration or fading, avoid getting cleaner on the projector case.*

Cleaning the Filters

The projector uses three filters to keep the fans free of dust and other particles, and should be cleaned every 500 hours of operation. In dusty environments, it is recommended to clean the filters more frequently. If the filter is dirty or clogged, your projector may overheat. When the message below is displayed, the filters must be cleaned.

Note:

When the Please clean filter message is displayed, please clean all three filters at the same time to synchronize the Filter time display.

The Filter Message item should be enabled in the Options menu.

Refer to the following guide to clean the filters.

1. The left-side and rear filters can be cleaned as demonstrated in the following images.

Note: Only clean the outside of the exhaust vents with a vacuum cleaner.

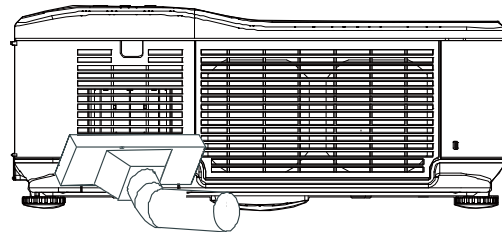
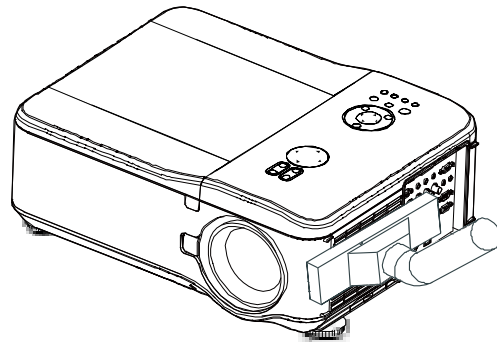

2. The rear exhaust vent can be accessed as shown.

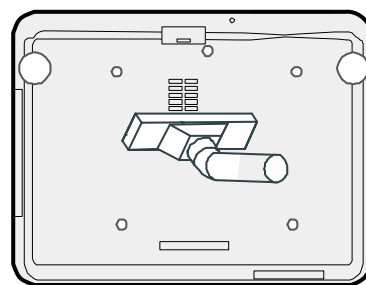

3. Gently slide the filter holders in the direction shown.

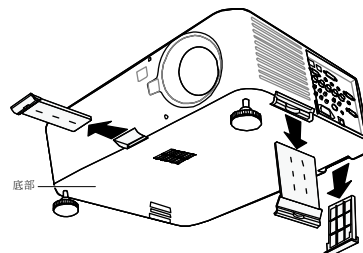

4. Lift the filter foams from all three filterholders in the direction shown. Remove them completely from each filterholder and discard.

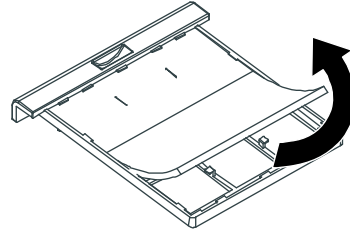

5. Place a replacement foam and press down firmly

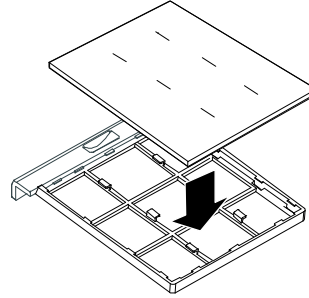

6. Replace the filter holders by pushing gently in the direction shown.

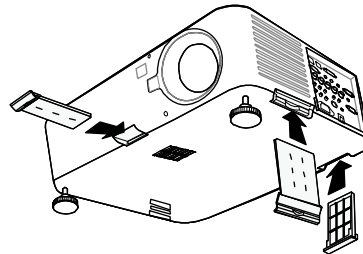

Once the filters are cleaned, please reset the filter timer by using the **Clear filter time** option in the on page

Replacing the Lamps

The projection lamps should be replaced when they burn out. They should only be replaced with a certified replacement part, contact your local dealer if unsure.

Note:

- Lamps are positioned differently. Take care not to force the lamps when replacing.
- Installation of both lamp modules (Lamp 1 and Lamp 2) is required to operate the projector in dual or single lamp mode. If only a single lamp module is installed, the projector's lamp will not turn on and will appear as a lamp failure.

Important:

- The lamp contains a certain amount of mercury and should be disposed of according to local ordinance regulations.
- Avoid touching the glass surface of the new lamp: doing so may shorten its operation life.

Caution:

Lamp Handling Precautions

- This projector uses a high-pressure lamp which must be handled carefully and properly. Improper handling may result in accidents, injury, or create a fire hazard.
- Lamp life may differ from lamp to lamp and according to the environment of use. There is no guarantee of the same life for each lamp. Some lamps may fail or terminate their life in a shorter period of time than other similar lamps.
- If the projector indicates that the lamp should be replaced, i.e., if LAMP 1 and/or LAMP 2 light up, replace the lamp with a new one IMMEDIATELY after the projector has cooled down. (Follow carefully the instructions in the Lamp Replacement section of this manual.) Continuous use of the lamp with LAMP 1 and/or LAMP 2 lighted may increase the risk of lamp explosion.
- A Lamp may explode as a result of vibration, shock or degradation as a result of hours of use as its lifetime draws to an end. Risk of explosion may differ according to the environment or conditions in which the projector and lamp are being used.

If a lamp explodes, the following safety precautions should be taken:

Disconnect the projector's AC plug from the AC outlet immediately. Contact an authorized service station for a checkup of the unit and replacement of the lamp. Additionally, check carefully to ensure that there are no broken shards or pieces of glass around the projector or coming out from the cooling air circulation holes. Any broken shards found should be cleaned up carefully. No one should check the inside of the projector except those who are authorized trained technicians and who are familiar with projector service. Inappropriate attempts to service the unit by anyone, especially those who are not appropriately trained to do so, may result in an accident or injury caused by pieces of broken glass. The projection lamp should be replaced when it burns out. It should only be replaced with a certified replacement part, which you can order from your local dealer.

Warning:

Be sure to turn off and unplug the projector at least 30 minutes before replacing the lamp. Failure to do so could result in a severe burn.

Note:

Safety glasses should be worn when replacing the lamp while the projector is ceiling mounted.

1. Remove the four screws on the lamp cover (A), and lift the lamp cover as shown (B).

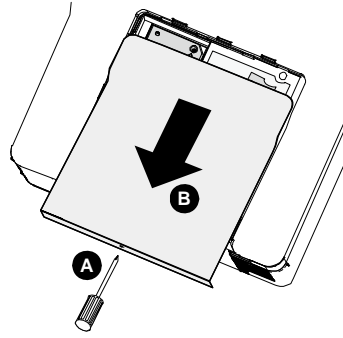

2. Loosen the two captive screws on the lamp module (A). Lift the module handle up as shown (B).

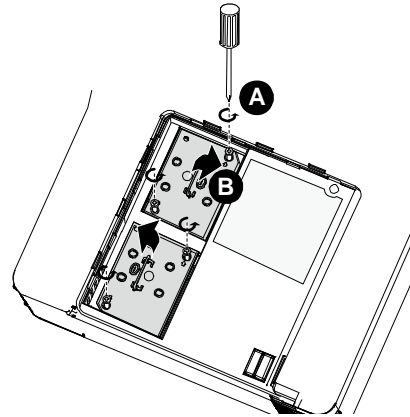

3. Pull firmly on the module handle in the direction shown to remove the lamp.

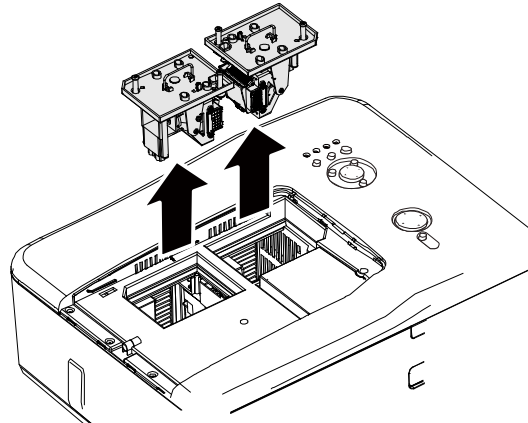

4. Reverse steps 1 to 3 to install the new lamp module(s) and replace the lamp cover.

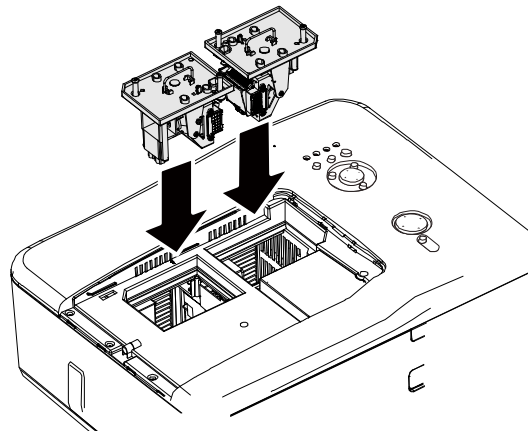

Troubleshooting

Indicator Messages

Several indicator messages are used by the projector to alert users of problems with setup or internal parts. The LEDs on the top surface of the projector show the status of the WARNING and lamp 1/2 as well as the general working order of the projector through the WARNING LED.

The following tables describe the various states of the 4 LEDs.

LED INDICATOR	LED CONDITION	PROJECTOR STATUS
Power Indicator	Off	AC off
	Red on	Standby
	Green on	Power on
	Orange blinks	Projector is under cooling
	Green blinks	Start up
Lamp indicator	Green on	Normal, lamp mode is set to Normal
	Orange on	Normal, lamp mode is set to ECO
	Green blinks	Lamp model is set to Normal and is warming up
	Orange blinks	Lamp model is set to Eco and is warming up
Warning indicator	Red blinks	The lamp cover is open.
	Red blinks 2 times	<p>The internal temperature is abnormally high.</p> <ul style="list-style-type: none"> ■ The temperature around the projector are high <ul style="list-style-type: none"> ✓ Use the projector in an environment with the temperature of lower than 104°F (40°C). ■ Air intake may be blocked. <ul style="list-style-type: none"> ✓ Relocate the projector to an area with proper ventilation. ■ Internal circuit may be fail.
	Orange blinks	<p>The internal temperature is abnormally high.</p> <ul style="list-style-type: none"> ■ Cooling fan breakdown. ■ Air intake may be blocked ■ Internal circuit may be fail. <p>Contact with your nearest authorized dealer or service center.</p>
Lamp indicator	Red blinks	<p>The lamp does not illuminate</p> <ul style="list-style-type: none"> ■ No lamp is installed or lamp should be replaced. <ul style="list-style-type: none"> ✓ Install the lamp or check if the lamp is installed properly.
	Red blinks 2 times (Repeatedly)	<p>The lamp does not illuminate</p> <ul style="list-style-type: none"> ■ The lamp is shut down abnormally. ■ The lamp is burnt out ■ Lamp circuit failure <p>Contact with your nearest authorized dealer or service center.</p>

Common Problems and Solutions

These guidelines provide tips to deal with problems you may encounter while using the projector. If the problem remains unsolved, contact your dealer for assistance.

Often the problem is something as simple as a loose connection. Check the following before proceeding to the problem-specific solutions.

- Use some other electrical device to confirm that the electrical outlet is working.
- Ensure the projector is turned on.
- Ensure all connections are securely attached.
- Ensure the attached device is turned on.
- Ensure a connected PC is not in suspend mode.
- Ensure a connected notebook computer is configured for an external display. (This is usually done by pressing an Fn-key combination on the notebook.)

Tips for Troubleshooting

In each problem-specific section, try the steps in the order suggested. This may help you to solve the problem more quickly.

Try to pinpoint the problem to avoid replacing non-defective parts.

For example, if you replace batteries and the problem remains, put the original batteries back and go to the next step.

Keep a record of the steps you take when troubleshooting: The information may be useful when calling for technical support or for passing on to service personnel.

Image Problems

Problem: No image appears on the screen

1. Verify the settings on your notebook or desktop PC.
2. Turn off all equipment and power up again in the correct order.

Problem: The image is blurred

1. Adjust the **Focus** on the projector .
3. Press the **AUTO** button on the remote control or projector.
4. Ensure the projector-to-screen distance is within the specified range.
5. Check that the projector lens is clean.
6. Remove the lens cover.

Problem: The image is wider at the top or bottom (trapezoid effect)

1. Position the projector so it is as perpendicular to the screen as possible.
2. Use the Keystone button on the remote control to correct the problem.

Problem: The image is reversed or upside down

- Check the **Ceiling & Rear** setting on the **Setting** menu of the OSD.

Problem: The image is streaked

1. Adjust the Phase and Clock on the Signal menu of the OSD to the default settings.
2. To ensure the problem is not caused by a connected PC's video card, connect to another computer.

Problem: The image is flat with no contrast

1. Adjust the **Contrast** setting on the **Picture** menu of the OSD.
2. Adjust the **Brightness** setting on the **Picture** menu of the OSD.

Problem: The color of the projected image does not match the source image.

- Adjust the **Color temperature** and **Picture** settings.

Lamp Problems

Problem: There is no light from the projector

1. Check that the power cable is securely connected.
2. Ensure the power source is good by testing with another electrical device.
3. Restart the projector in the correct order and check that the Power LED is green.
4. If you have replaced the lamp recently, try resetting the lamp connections.
5. Replace the lamp module.
6. Remove the lens cap.
7. Put the old lamp back in the projector and have the projector serviced.

Problem: The lamp goes off

8. Power surges can cause the lamp to turn off. Press the power button twice to turn off the projector. When the Power LED is orange, press the power button.
9. Replace the lamp module.
10. Put the old lamp back in the projector and have the projector serviced.

Remote Control Problems

Problem: The projector does not respond to the remote control

1. Direct the remote control towards remote sensor on the projector.
2. Ensure the path between remote and sensor is not obstructed.
3. Turn off any fluorescent lights in the room.
4. Check the battery polarity.
5. Replace the batteries.
6. Turn off other Infrared-enabled devices in the vicinity.
7. Have the remote control serviced.
8. Ensure that the remote control code conforms to the projector's code.
9. Ensure that the reset switch in the compartment lid on back of the remote control is set to use position.

Having the Projector Serviced

If you are unable to solve the problem, you should have the projector serviced. Pack the projector in the original carton. Include a description of the problem and a checklist of the steps you took when trying to fix the problem. The information may be useful to the service personnel. Return the projector to the place you purchased it.

SPECIFICATIONS

Projector Specifications

Model		DX6530/DX6535	DW6030/DW6035
Display Devices		0.7", 1- DLP Chip	0.65", 1-DLP Chip
Resolution		XGA(1024x768)	WXGA(1280x800)
Optional Lens (Standard Lens)	F number	F 1.64 ~1.86	
	Zoom	Power, 1.3X,(f=26.0-34.0mm)	
	Focus	Power	
Lens Shift		Power(V: +50% / H: ±10%)	
Projection Lamp		280W x 2 lamps	
Input Terminals	DV-D(Compatible with HDCP)	X1	
	Computer/Component(5BNC)	X1	
	Computer/Component(D-sub 15p)	X1	
	Component(RCA)	X1, Y/Pb(Cb)/Pr(Cr)	
	S-Video(min Din 4 pin)	X1	
	Video(RCA)	X1	
Output Terminals	Computer/Component(D-sub 15 p)	X1	
	Trigger	X1 (DC 12V Output)	
Control and Service terminal	Lan(RJ-45)	X1	
	RS-232C	X1	
	USB(Type B) for service	X1	
Power Requirement		AV 100 - 240V, 50/60Hz	
Input Current		7.3A	
Power Consumption(standby Mode: Standard/Eco)		715W(20.3W/<0.5W) with AC 110V 675W(21.3W/<0.5W) with AC 240V	
Operation Temperature		41°F to 104°F (5°C to 40°C)	
Storage Temperature		14°F to 140°F(-10°C to 60°C), 5% to 90% humidity (non-condensing)	
Dimensions		20" (W) x 7.7" (H) x 15.3" (D) 508 mm (W) x 195 mm (H) x 389 mm (D) (not including protrusions)	
Weight		37.5 lb/17 kg	

Lens options

The parts listed below are optionally available. When ordering those parts, specify the item name and Model No. to the sales dealer.

Part number	Projection Lens	F Number	Focus Length (mm)	Throw Ratio	
				DX6530/35	DW6030/35
D88-WF18501	Wide Fix Lens	1.85	f=11.6	0.79:1	0.8:1
D88-WZ01	Wide Zoom Lens	1.85-2.5	f=18.7-26.5	1.30-1.85:1	1.31-1.87:1
D88-ST001	Standard Zoom Lens	1.7-1.9	f=26.0-34.0	1.79-2.35:1	1.81-2.38:1
D88-SMLZ01	Semi-Long Zoom Lens	1.86-2.48	f=32.9-54.2	2.30-3.81:1	2.33-3.86:1
D88-LOZ101	Long Zoom1 Lens	1.85-2.41	F=52.8-79.1	3.71-5.57:1	3.76-5.64:1
D88-LOZ201	Long Zoom2 Lens	1.85-2.48	F=78.5-121.9	5.50-8.56:1	5.56-8.67:1

Cabinet Dimensions

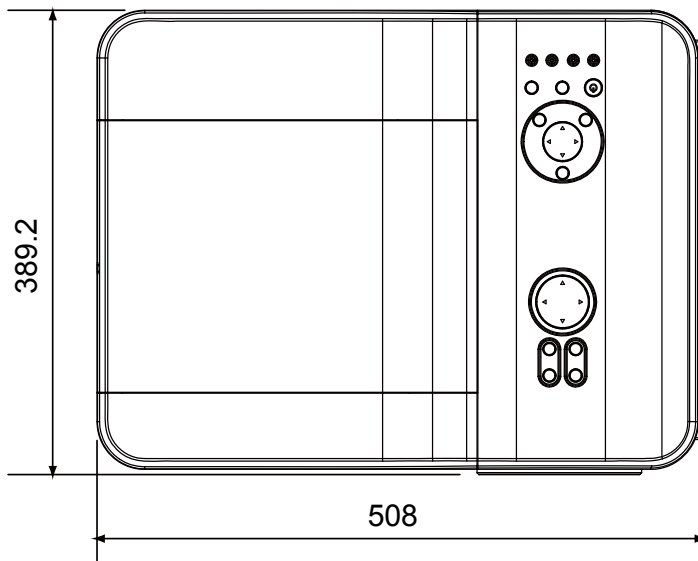
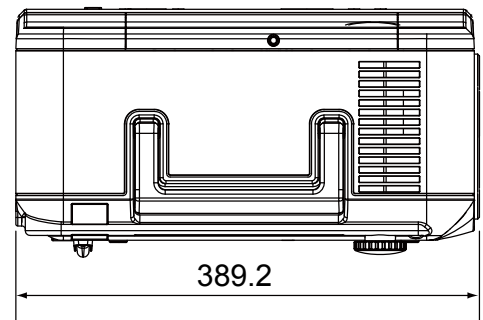
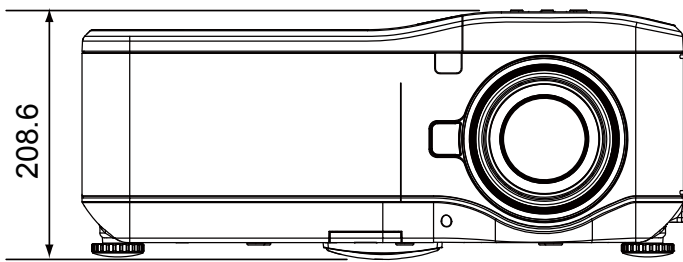

Pin Assignments of Mini D-Sub 15 Pin Input Connector

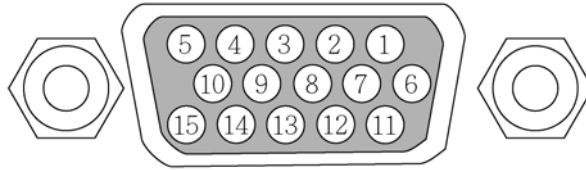

Signal Levels
 Video signal: 0.7Vp-p (Analog)
 Sync signal: TTL level

PIN NUMBER	RGB SIGNAL (ANALOG)	YCbCr SIGNAL
1	Red	Cr
2	Green or Sync on Green	Y
3	Blue	Cb
4	Ground	
5	Ground	
6	Red Ground	Cr Ground
7	Green Ground	Y Ground
8	Blue Ground	Cb Ground
9	No Connection	
10	Sync Signal Ground	
11	No Connection	
12	Bi-directional DATA (SDA)	
13	Horizontal Sync or Composite Sync	
14	Vertical Sync	
15	Data Clock	

Compatible Input Signal List

The following table shows compatible signal types, their resolution and frequency refresh rates.

Horizontal: 15kHz, 31kHz to 90 kHz, Vertical: 50 Hz to 85 Hz

Mode	Resolution	H-Sync (KHz)	V-Sync (Hz)	Analog	Digital
VGA	640x480	31.5	60	o	o
		37.9	72	o	o
		37.5	75	o	o
		43.3	85	o	
SVGA	800x600	35.2	56	o	o
		37.9	60	o	o
		48.1	72	o	o
		46.9	75	o	o
		53.7	85	o	o
XGA	1024x768	48.4	60	o	
		56.5	70	o	o
		60.0	75	o	o
		68.7	85	o	
WXGA	1280x720	45.0	60	o	o
	1280x768	47.8	60	o	o
	1280x800	49.7	60	o	o
		62.8	75	o	
	1360x768	47.7	60		o
	1366x768	47.7	60		o
WXGA+	1440x900	55.9	60	o	
SXGA	1152x864	67.5	75	o	
	1280x960	60	60	o	o
		64.0	60	o	o
	1280x1024	80.0	75	o	o
SXGA+	1400x1050	65.3	60	o	o
WSXGA+	1680x1050	65.3	60	o	
UXGA	1600x1200	75.0	60	o	
VGA (MAC 13")	640 x480	34.9	67	o	
SVGA (MAC 16")	832x624	49.7	75	o	
XGA (MAC 19")	1024x768	60.2	75	o	
SXGA (MAC 21")	1152x870	68.7	75	o	

3D Supported Timing

Mode	Resolution	H-Sync (KHz)	V-Sync (Hz)	Analog	Digital
VGA	800x600	37.9	60	o	o
		77.1	120		
XGA	1024x768	48.4	60	o	o
		98.6	120		
WXGA	1280x800	49.7	60	o	o
		101.6	120		
	1280x720	45.0	60	o	
		92.6	120		

DVT

Signal	Vertical Frequency(Hz)	Horizontal Frequency(Hz)	Analog	Digital	
SDTV	480i	15.7	60.0	○	
	576i	15.6	50.0	○	
EDTV	480p	31.5	60.0	○	○
	576p	31.3	50.0	○	○
HDTV	720p	45.0	60.0	○	○
	720p	37.5	50.0	○	○
	1080i	33.8	60.0	○	○
	1080i	28.1	50.0	○	○
	1080p	56.3	50	○	○
	1080p	67.5	60	○	○

Note:

- An image with higher or lower resolution than the projector's native resolution will be compressed.
- Some Composite and Sync on Green signals may not be displayed correctly.
- Signals other than those specified in the table above may not be displayed correctly. If this should happen, change the refresh rate or resolution on your PC. Refer to Display Properties help section of your PC for procedures.

RS232 Control Commands and Cable Connections

This projector provides a function to control and monitor the projector's operations by using the RS-232C serial port.

Cable Connection

Connector (DIN-9P)

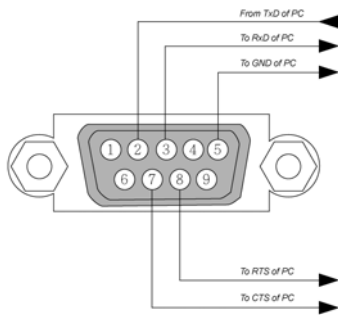

Pin 1, 4, 6 and 9 are not used.

RS232C Connection

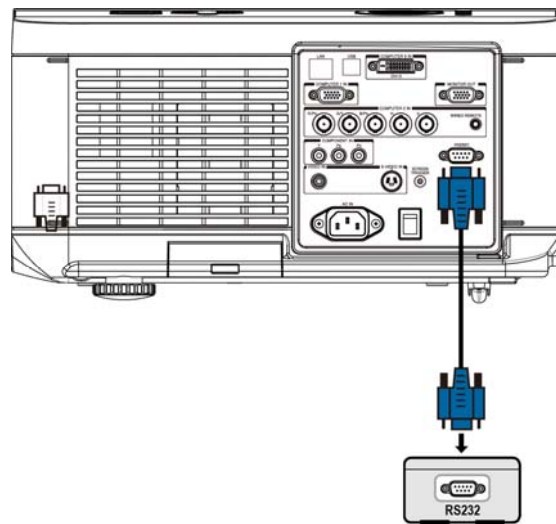

Note:

- Jumper "Request to Send" and "Clear to Send" together on both ends of the cable to simplify the cable connection.

Control Command

There are two types of the command, Get commands and Set Command, the command is structured by the Header code, command code, data code and end code. All of commands contain ASCII test string ending with an ASCII carriage return character.

For example:

Set Command	<header code>S<command>[CR]	
	<u>Set Power On</u>	
	ASCII: V99 S 0001 [CR]	Projector return: P
	Hex : 56 39 39 53 30 30 30 31 0D	Projector return: 50
Set Command with data	<header code>S<command><data>[CR]	
	<u>Set brightness to 25</u>	
	ASCII: V99 S 0101 25 [CR]	Projector return: P
	Hex : 56 39 39 53 30 31 30 31 32 35 0D	Projector return: 50
Set Command	<header code>G<command>[CR]	
	<u>Get brightness (brightness is 18)</u>	
	ASCII: V99 G 0101 [CR]	Projector return: P 18
	Hex : 56 39 39 47 30 31 30 31 0D	Projector return: 50 31 38

The operation commands are divided into five group (00-04), the group number is the first two digits of the command.

Command Group 00

Operation	ASCII	HEX	Description	Return String
Set Power On	V99S0001	56H 39H 39H 53H 30H 30H 30H 31H 0DH		P/F
Set Power Off	V99S0002	56H 39H 39H 53H 30H 30H 30H 32H 0DH		P/F
Set Auto Image	V99S0003	56H 39H 39H 53H 30H 30H 30H 33H 0DH		P/F
Get Lamp 1 usage	V99G0004	56H 39H 39H 47H 30H 30H 30H 34H 0DH		Pn/F
Get Filter Timer	V99G0005	56H 39H 39H 47H 30H 30H 30H 35H 0DH	N=0~999999	Pn/F
Set System Reset	V99S0006	56H 39H 39H 53H 30H 30H 30H 36H 0DH		P/F
Get System Status	V99G0007	56H 39H 39H 47H 30H 30H 30H 37H 0DH	0: Reset 1: Standby 2: Operation 3: Cooling	Pn/F
Get Firmware Version	V99G0008	56H 39H 39H 47H 30H 30H 30H 38H 0DH		Pn/F
Get Lamp 2 usage	V99G0010	56H 39H 39H 47H 30H 30H 31H 30H 0DH		Pn/F

Command Group 01

Operation	ASCII	HEX	Description	Return String
Get Brightness setting	V99G0101	56H 39H 39H 47H 30H 31H 30H 31H 0DH	N=-30~30	Pn/F
Set the Brightness	V99S0101n	56H 39H 39H 53H 30H 31H 30H 31H n 0DH	N=-30~30	P/F
Get contrast setting	V99G0102	56H 39H 39H 47H 30H 31H 30H 32H 0DH	N=-30~30	Pn/F
Set the Contrast	V99S0102n	56H 39H 39H 53H 30H 31H 30H 32H n 0DH	N=-30~30	P/F
Get Color setting	V99G0103	56H 39H 39H 47H 30H 31H 30H 33H 0DH	N=-30~30	Pn/F
Set the Color	V99S0103n	56H 39H 39H 53H 30H 31H 30H 33H n 0DH	N=-30~30	P/F
Get Tint setting	V99G0104	56H 39H 39H 47H 30H 31H 30H 34H 0DH	N=-30~30	Pn/F
Set the Tint	V99S0104n	56H 39H 39H 53H 30H 31H 30H 34H n 0DH	N=-30~30	P/F
Get Sharpness setting	V99G0105	56H 39H 39H 47H 30H 31H 30H 35H 0DH	N=-30~30	Pn/F
Set the Sharpness	V99S0105n	56H 39H 39H 53H 30H 31H 30H 35H n 0DH	N=-30~30	P/F
Get the Color Temperature	V99G0106	56H 39H 39H 47H 30H 31H 30H 36H 0DH	0: Warm 1: Standard 2: Cold	Pn/F
Set the Color Temperature	V99S0106n	56H 39H 39H 53H 30H 31H 30H 36H n 0DH	0: Warm 1: Standard 2: Cold	P/F

Command Group 02

Operation	ASCII	HEX	Description	Return String
Set Input source to RGB	V99S0201	56H 39H 39H 53H 30H 32H 30H 31H 0DH		P/F
Set Input source to BNC	V99S0202	56H 39H 39H 53H 30H 32H 30H 32H 0DH		P/F
Set Input source to Component	V99S0203	56H 39H 39H 53H 30H 32H 30H 33H 0DH		P/F
Set Input source to Video	V99S0204	56H 39H 39H 53H 30H 32H 30H 34H 0DH		P/F
Set Input source to S-Video	V99S0205	56H 39H 39H 53H 30H 32H 30H 35H 0DH		P/F
Set Input source to DVI	V99S0206	56H 39H 39H 53H 30H 32H 30H 36H 0DH		P/F
Get current Input source	V99G0220	56H 39H 39H 47H 30H 32H 32H 30H 0DH	0:RGB 1:BNC 2:Component 3:Video 4:S-Video 5:DVI	Pn/F

Command Group 03

Operation	ASCII	HEX	Description	Return String
Get Aspect Ratio setting	V99G0301	56H 39H 39H 47H 30H 33H 30H 31H 0DH	0: Normal 1: Full 2: 4:3 3 :16:9 4 :Native	Pn/F
Set Aspect Ratio	V99S0301n	56H 39H 39H 53H 30H 33H 30H 31H n 0DH	0: Normal 1: Full 2: 4:3 3 :16:9 4 :Native	P/F
Get Blank setting	V99G0302	56H 39H 39H 47H 30H 33H 30H 32H 0DH	0: Off 1: On	Pn/F
Set Blank	V99S0302n	56H 39H 39H 53H 30H 33H 30H 32H n 0DH	0: Off 1: On	P/F
Get Freeze setting	V99G0304	56H 39H 39H 47H 30H 33H 30H 34H 0DH	0: Off 1: On	Pn/F
Set Freeze setting	V99S0304n	56H 39H 39H 53H 30H 33H 30H 34H n 0DH	0: Off 1: On	P/F
Get Projection Mode	V99G0308	56H 39H 39H 47H 30H 33H 30H 38H 0DH	0:Front 1:Rear 2:Ceiling + Front 3:Ceiling + Rear	Pn/F
Set Projection Mode	V99S0308n	56H 39H 39H 53H 30H 33H 30H 38H n 0DH	0:Front 1:Rear 2:Ceiling + Front 3:Ceiling + Rear	P/F
Get Keystone setting	V99G0309	56H 39H 39H 47H 30H 33H 30H 39H 0DH	n= -80~80	Pn/F
Set Keystone	V99S0309n	56H 39H 39H 53H 30H 33H 30H 39H n 0D	n= -80~80	P/F
Get Messaging setting	V99G0315	56H 39H 39H 47H 30H 33H 31H 35H 0DH	0: On 1: Off	Pn/F
Set Messaging	V99S0315n	56H 39H 39H 53H 30H 33H 31H 35H n 0DH	0: On 1: Off	P/F
Get Communication Speed	V99G0316	56H 39H 39H 47H 30H 33H 31H 36H 0DH	0: 9600bps 1: 19200bps 2:: 38400bps	Pn/F
Set Communication Speed	V99S0316n	56H 39H 39H 53H 30H 33H 31H 36H n 0DH	0: 9600bps 1: 19200bps 2:: 38400bps	P/F

Command Group 04(Remote Control Buttons)

Operation	ASCII	HEX	Description	Return String
ON	V99S0401	56H 39H 39H 53H 30H 34H 30H 31H 0DH		P/F
OFF	V99S0402	56H 39H 39H 53H 30H 34H 30H 32H 0DH		P/F
FOCUS+	V99S0403	56H 39H 39H 53H 30H 34H 30H 33H 0DH		P/F
FOCUS-	V99S0404	56H 39H 39H 53H 30H 34H 30H 34H 0DH		P/F
TEST PATTERN	V99S0407	56H 39H 39H 53H 30H 34H 30H 37H 0DH		P/F
LENS SHIFT	V99S0408	56H 39H 39H 53H 30H 34H 30H 38H 0DH		P/F
UP	V99S0409	56H 39H 39H 53H 30H 34H 30H 39H 0DH		P/F
DOWN	V99S0410	56H 39H 39H 53H 30H 34H 31H 30H 0DH		P/F
LEFT	V99S0411	56H 39H 39H 53H 30H 34H 31H 31H 0DH		P/F
RIGHT	V99S0412	56H 39H 39H 53H 30H 34H 31H 32H 0DH		P/F
ENTER	V99S0413	56H 39H 39H 53H 30H 34H 31H 33H 0DH		P/F
MENU	V99S0414	56H 39H 39H 53H 30H 34H 31H 34H 0DH		P/F
RETURN	V99S0415	56H 39H 39H 53H 30H 34H 31H 35H 0DH		P/F
INPUT	V99S0416	56H 39H 39H 53H 30H 34H 31H 36H 0DH		P/F
PICTURE	V99S0417	56H 39H 39H 53H 30H 34H 31H 37H 0DH		P/F
Blank	V99S0418	56H 39H 39H 53H 30H 34H 31H 38H 0DH		P/F
AUTO SYNC	V99S0419	56H 39H 39H 53H 30H 34H 31H 39H 0DH		P/F
ASPECT	V99S0420	56H 39H 39H 53H 30H 34H 32H 30H 0DH		
OVERSCAN	V99S0423	56H 39H 39H 53H 30H 34H 32H 33H 0DH		P/F
FREEZE	V99S0424	56H 39H 39H 53H 30H 34H 32H 34H 0DH		P/F
3D MODE	V99S0425	56H 39H 39H 53H 30H 34H 32H 35H 0DH		P/F
INFO.	V99S0426	56H 39H 39H 53H 30H 34H 32H 36H 0DH		P/F

Screen Trigger

When the projector is powered ON the screen trigger output sends a low voltage trigger to the screen controller and the screen will go down. When the projector is powered OFF the screen trigger stops sending a low voltage trigger to the screen controller and the screen will go up.

Note:

See *Screen Trigger* on page 5 for more information.

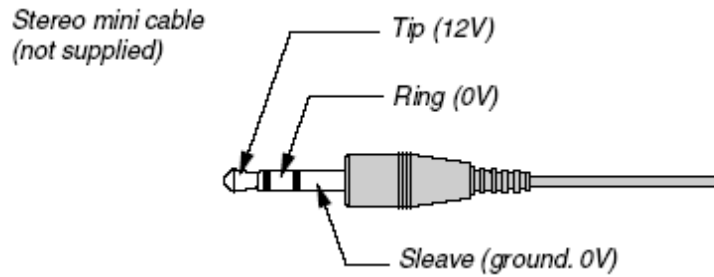

Note:

Screen controllers are supplied and supported by screen manufacturers.

Note:

Do not use this jack for anything other than intended use.

Operation Using HTTP Browser

Overview

The use of HTTP server functions will allow control of the projector from a web browser without the installation of special software. Please be sure to use “Microsoft Internet Explorer 4.x” or a higher version for the web browser. (This device uses “JavaScript” and “Cookies” and the browser should be set to accept these functions. The setting method will vary depending on the version of browser. Please refer to the help files and the other information provided in your software).

Access is gained to the HTTP server functions by specifying the following address in the entry column of the URL:

http:// <the projector's IP address> /index.html

http:// <the projector's IP address> /lanconf.html

Note:

The display or button responses can be slowed down or operation may not be accepted depending the settings of your network. Should this happen, consult your network administrator. The projector may not respond if its buttons are repeatedly pressed in rapid intervals. Should this happen, wait a moment and repeat. If you still can't get any response, turn off and back on the projector.

Preparation Before Use

Make network connections, set up the projector and confirm that it is complete before engaging in browser operations

Operation with a browser that uses a proxy server may not be possible depending on the type of proxy server and the setting method. Although the type of proxy server will be a factor, it is possible that items that have actually been set will not be displayed depending on the effectiveness of the cache, and the contents set from the browser may not be reflected in operation. It is recommended that a proxy server not be used unless it is unavoidable.

Handling of the Address for Operation by Using a Browser

Regarding the actual address that is entered for the address or entered to the URL column when operation of the projector is via a browser, the host name can be used as it is when the host name corresponding to the IP address of the projector has been registered to the domain name server by a network administrator, or the host name corresponding to the IP address of the projector has been set in the “HOSTS” file of the computer being used.

Example 1:

When the IP address of the projector is **192.168.150.2**, access is gained to the HTTP server functions by specifying **http:// 192.168.150.2/index.html** for the address or the entry column of the URL.

Configuring Network Settings

The Network Settings screen is displayed as follows:

http:// <the projector's IP address> /lanconf.html

Projector

DOMAIN

Host Name

Domain Name

Apply

MAIL

Error Mail Enable Disable

Originator Address

SMTP Server

Recipient Address 1

Recipient Address 2

Recipient Address 3

Apply

TEST MAIL

Execute

Test Mail Status

PJLink

PJLink(Passwd) On Off

Password

Apply

DOMAIN

Host Name: Type in a host name, up to 60 alphanumeric characters can be used.

Domain Name: Type in domain name of the network connected to the projector. Up to 60 alphanumeric characters can be used.

Apply: Click to reflect the entries.

MAIL

Error Mail: Click "Enable" to enable Error Mail feature. This option notifies your computer of an error message via e-mail when using wired LAN. The error message will be notified when the projector lamp has reached the end of its usable life or an error occurs in the projector.

Originator Address: Specify the sender's address. Up to 60 alphanumeric and symbols, characters can be used.

SMTP Server Name: Type in the SMTP server name to be connected to the projector. Up to 60 alphanumeric characters can be used.

Recipient's Address 1 to 3: Type in your recipient's address. Up to 60 alphanumeric and symbols characters can be used.

Apply: Click to apply the settings.

TEST MAIL

Send a test mail to check if your settings are correct. Click to “Execute” to enable this feature.

Test Mail Status Button: Click to display the test result.

Sample of a message sent from the projector:

Projector Name: X X X X

Lamp 1 or 2 Hours Used: xxxx [H]

The lamp is at the end of its usable life. Please replace the lamp.

Note:

- If you entered an incorrect address in a test, you may not receive an Alert mail. Should this happen, check if the Recipient's Address is correctly set.
- Unless any one of the [Sender's Address], [SMTP Server's Name] or [Recipient's Address 1-3] is selected, [Test Mail] is not available.

PJLINK

This option allows you to set a password when you use the PJLink feature.

On/Off: Enable or disable the password.

Password: Enter a password (up to 32 characters)

Note:

- PJLink is a standardization of protocol used for controlling projectors of different manufacturers. This standard protocol is established by Japan Business Machine and Information System Industries Association (JBMIA) in 2005.
- The projector supports all the commands of PJLink Class 1.

PROJECTOR INPUT	PJLINK INPUT	PARAMETER
Computer 1	RGB 1	11
Computer 2	RGB 2	12
Video	VIDEO 1	21
S-Video	VIDEO 2	22
Component	VIDEO 3	23
Computer 3	DIGITAL 1	31



Structure of the HTTP Server

Once the projector is connected to a network and configured correctly, the following screen is displayed through the web browser.

http:// <the projector's IP address> /index.html

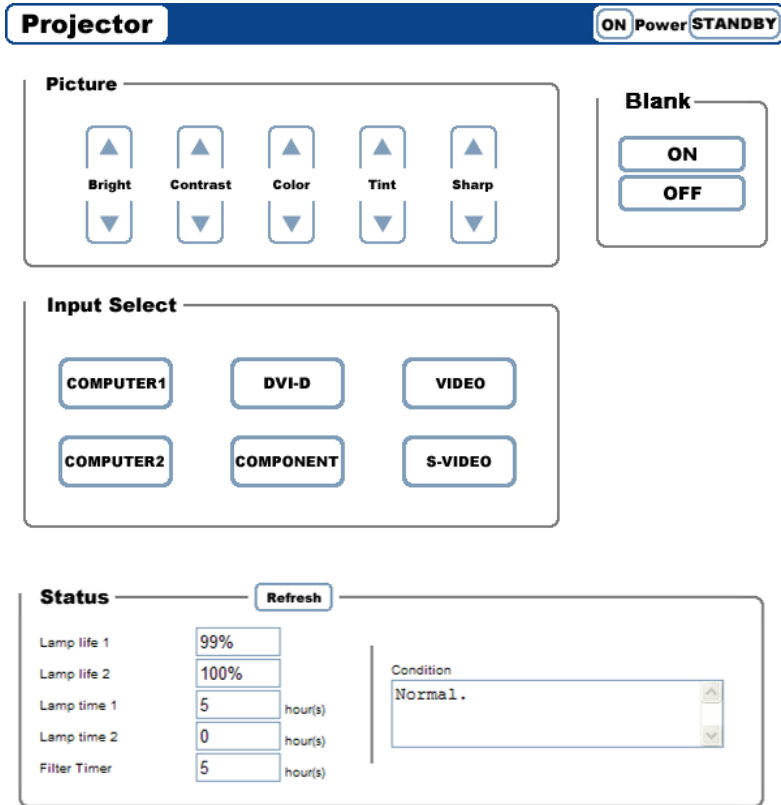

FUNCTION	SETTING	DESCRIPTION
POWER	ON STANDBY	This controls the power to the projector
Blank	ON – Blank the screen OFF – Display the projected image	This controls the Blank functions of the projector
PICTURE	BRIGHTNESS ▲▼ – Increases or decreases the brightness CONTRAST ▲▼ – Increases or decreases the contrast COLOR ▲▼ – Increases or decreases the color value TINT ▲▼ – Increases or decreases the hue value SHARPNESS ▲▼ – Increases or decreases the sharpness	Controls the video adjustments of the projector
INPUT SELECT	COMPUTER1 – Switches to the COMPUTER 1 IN source COMPUTER2 – Switches to the COMPUTER 2 IN source COMPUTER3 – Switches to the DVI-D DCOMPUTER 3 IN source COMPONENT – Switches to the COMPONENT IN source VIDEO – Switches to the VIDEO IN source S-VIDEO – Switches to the S-VIDEO IN source	This switches the input connector of the projector

FUNCTION	SETTING	DESCRIPTION
STATUS	Refresh – Updates the panel with the latest information Lamp1 life – Displays the remaining life of Lamp 1 as a percentage Lamp2 life – Displays the remaining life of Lamp 2 as a percentage Lamp1 time – Displays the number of hours Lamp 1 has been used Lamp2 time – Displays the number of hours Lamp 2 has been used Filter Timer- Display the number of hours counted from last filter timer reset PJ time – Displays the number of hours the project has been used	This displays the status of selected projector functions

Note:

- *The functions that can be controlled will vary depending on the signal being input to the projector (see [Selecting an Input Source](#) on page 20 for more information).*
- *Standby Mode has to be set to Standard before using HTTP server.*
- *The lamp life percentage shown here is based on expected lamp life in controlled laboratory conditions. Actual life may vary depending on installation environment, orientation and lamp mode*

REGULATORY COMPLIANCE

FCC Warning

This equipment has been tested and found to comply with the limits for a Class **A** digital device pursuant to Part 15 of the FCC Rules. These limits are designed to provide reasonable protection against harmful interference when the equipment is operated in a commercial environment.

This equipment generates, uses, and can radiate radio frequency energy and, if not installed and used in accordance with the instruction manual, may cause harmful interference to radio communications.

Operation of this equipment in a residential area is likely to cause harmful interference in which case the user will be required to correct the interference at his/her own expense.

Changes or modifications not expressly approved by the parties responsible for compliance could void the user's authority to operate the equipment.

Canada

This class A digital apparatus complies with Canadian IECS-003.

Safety Certifications

UL, cUL, FCC, PSB, CCC, and KC.

EN 55022 Warning

This is a Class A product. In a domestic environment, it may cause radio interference, in which case the user may be required to take adequate measures. The typical use is in a conference room, meeting room, or auditorium.